

# SD98

www.ersatzteile.com  
**TELAIO**  
**CHASSIS**  
**CHASSIS**  
**RAHMENSATZ**

2009

5101.0

1 / 2



N.	CODE	Q.TY	DESCRIZIONE	DESCRIPTION	DESCRIPTION	BESCHREIBUNG
1	24487998/0	1	COPPIGLIA	COTTER PIN	GOUILLE	SPLIT
2	25510079/0	2	PERNO	PIN	PIVOT	BOLZEN
3	12293201/0	2	DADO	NUT	ECROU	MUTTER
4	12735599/0	2	VITE	SCREW	VIS	SCHRAUBE
5	325547225/0	1	PIASTRINA DESTRA	RIGHT PLATE	PLAQUE DROITE	RECHTE PLATTE
6	325547227/0	1	PIASTRINA SINISTRA	LEFT PLATE	PLAQUE GAUCHE	LINKE PLATTE
11	382785169/0	1	SUPPORTO PIANTONE	STEERING COLUMN SUPPORT	SUPPORT TUBE DE DIRECTION	LENKUNGSAEULEHALTER
12	125943009/0	4	VITE	SCREW	VIS	SCHRAUBE
13	325785331/0	1	SUPPORTO SEDILE DESTRO	RIGHT SEAT SUPPORT	SUPPORT SIEGE DROITE	RECHTE SITZHALTER
14	325785333/0	1	SUPPORTO SEDILE SINISTRO	LEFT SEAT SUPPORT	SUPPORT SIEGE GAUCHE	LINKE SITZHALTER
15	125943009/0	6	VITE	SCREW	VIS	SCHRAUBE
16	382785179/0	1	SUPPORTO PEDANA	FOOTBOARD SUPPORT	SUPPORT MARCHEPIED	FUSSBRETTHALTER
17	125943009/0	2	VITE	SCREW	VIS	SCHRAUBE
18	125943009/0	2	VITE	SCREW	VIS	SCHRAUBE
20	325500041/0	1	PEDANA DESTRA	RIGHT FOOTBOARD	MARCHEPIED DROITE	RECHTE FUSSBRETT
21	325500043/0	1	PEDANA SINISTRA	LEFT FOOTBOARD	MARCHEPIED GAUCHE	LINKE FUSSBRETT
22	12735599/0	2	VITE	SCREW	VIS	SCHRAUBE
25	12293201/0	2	DADO	NUT	ECROU	MUTTER
26	325820109/0	1	SUPPORTO SEDILE	SEAT SUPPORT	SUPPORT SIEGE	SITZHALTER
27	125160048/0	2	DISTANZIALE	SPACER	ENTRETOISE	ENTFERNUNGSSTÜCK
28	125430263/0	2	MOLLA	SPRING	RESSORT	FEDER
29	325060038/0	1	CAMMA	CAM	CAME	NOCKEN
30	325820105/0	1	SUPPORTO	SUPPORT	SUPPORT	HALTER
31	125430264/0	2	MOLLA	SPRING	RESSORT	FEDER
32	12521350/0	2	ROSETTA	WASHER	RONDELLE	SCHEIBE
33	12691400/0	2	VITE	SCREW	VIS	SCHRAUBE
34	325122002/0	2	CUFFIAIO	HOOD	PROTECTEUR	SCHUTZKASTEN





N.	CODE	Q.TY	DESCRIZIONE	DESCRIPTION	DESCRIPTION	BESCHREIBUNG
35	382547061/0	1	PIASTRA	PLATE	PLAQUE	PLATTE
36	22524970/2	2	PERNO	PIN	PIVOT	BOLZEN
37	382820151/0	1	SUPPORTO SEDILE	SEAT SUPPORT	SUPPORT SIEGE	SITZHALTER
38	12155010/0	2	DADO	NUT	ECROU	MUTTER
39	118203854/0	2	CAPPUCCIO	PROTECTION	CAPUCHON	STECKER
40	125943009/0	4	VITE	SCREW	VIS	SCHRAUBE

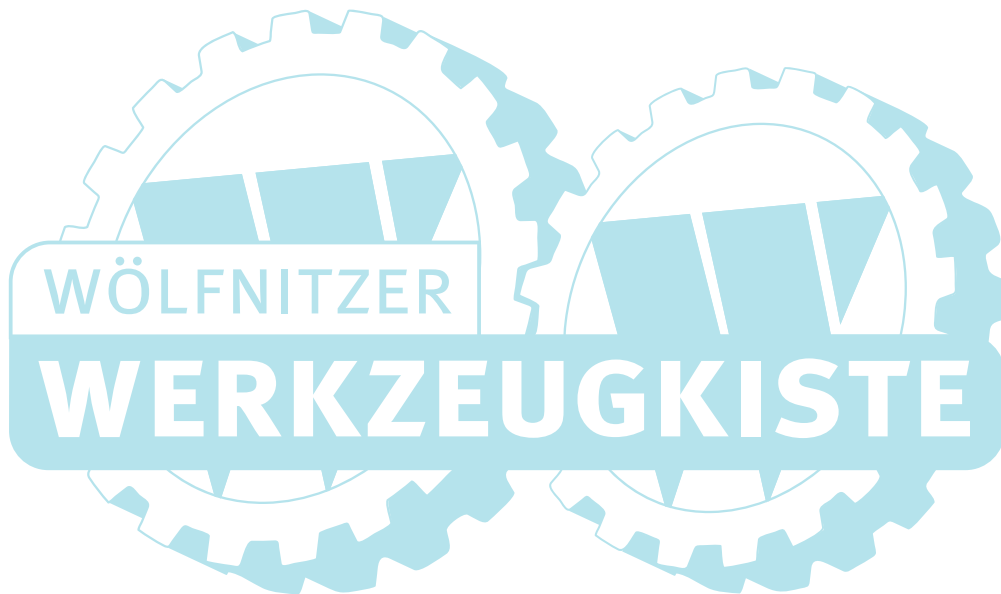

# SD98

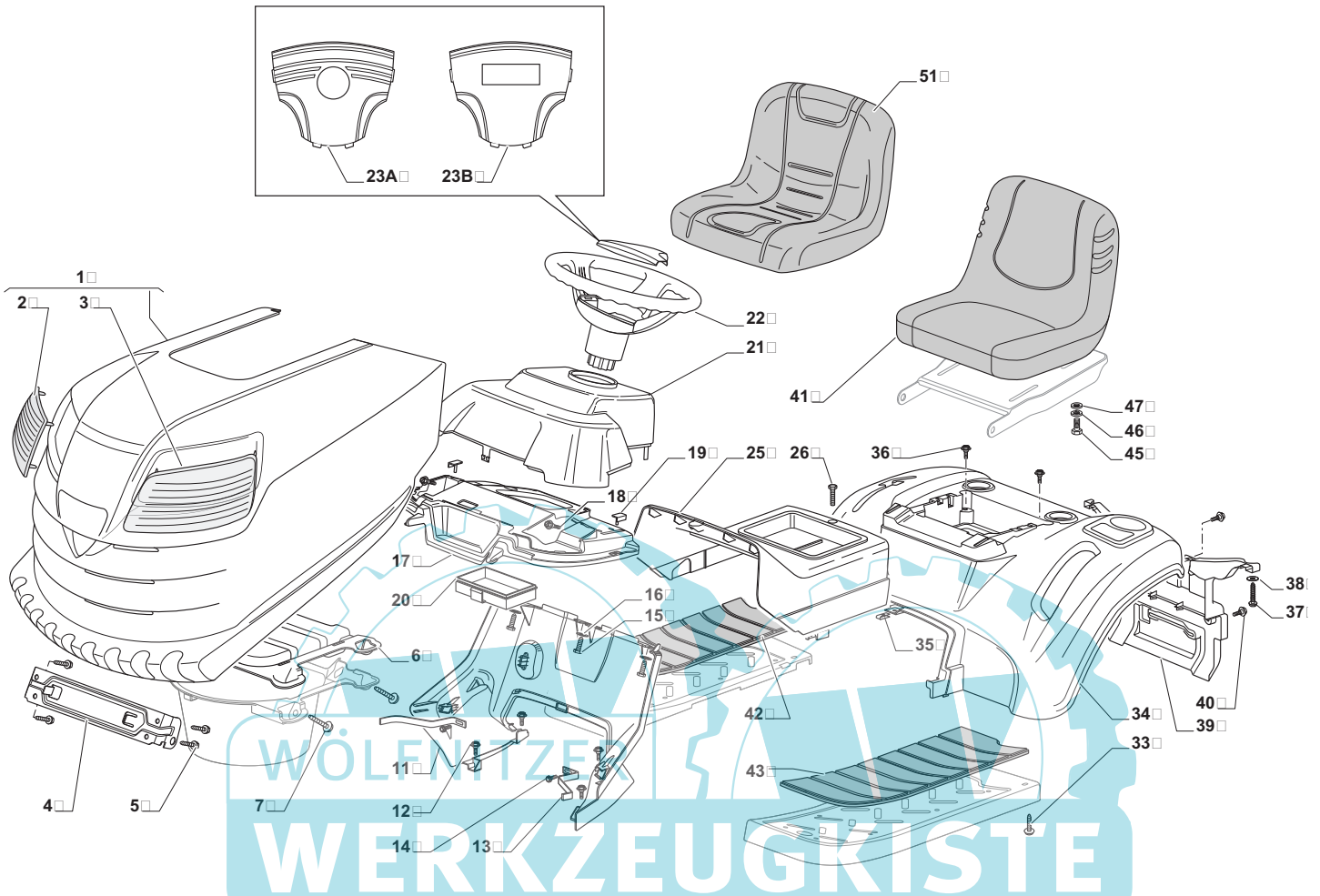

WÖLFFERT  
**WERKZEUGKISTE**

N.	CODE	Q.TY	DESCRIZIONE	DESCRIPTION	DESCRIPTION	BESCHREIBUNG
1	382076955/0	1	COFANO ROSSO	ENGINE HOOD RED	CAPOT ROUGE	HAUBESATZ ROT
1	382076954/0	1	COFANO GIALLO	ENGINE HOOD YELLOW	CAPOT JAUNE	HAUBESATZ GELB
2	325410887/0	1	MASCHERINA DESTRA	RIGHT GRILL	PANNEAU DROITE	RECHTE SCHUTZ
3	325410888/0	1	MASCHERINA SINISTRA	LEFT GRILL	PANNEAU GAUCHE	LINKE SCHUTZ
4	325785317/0	1	SUPPORTO COFANO	ENGINE HOOD SUPPORT	SUPPORT CAPOT	HAUBESATZHALTER
5	12735403/0	4	VITE	SCREW	VIS	SCHRAUBE
6	325263302/0	1	GRIGLIA ASPIRAZIONE	AIR INTAKE GRILL	GRILLE D'ASPIRATION	ANSAUGGITTER
7	112728692/0	4	VITE	SCREW	VIS	SCHRAUBE
11	325785298/0	1	SUPPORTO CRUSCOTTO	DASHBOARD SUPPORT	SUPPORT TABLEAU	KONSOLEHALTER
12	125943010/0	4	VITE	SCREW	VIS	SCHRAUBE
13	325270325/0	2	GUIDA	GUIDE	GUIDE	FÜHRUNG
14	12735599/0	2	VITE	SCREW	VIS	SCHRAUBE
15	112735406/0	3	VITE	SCREW	VIS	SCHRAUBE
16	12523040/0	3	ROSETTA	WASHER	RONDELLE	SCHEIBE
17	325120202/0	1	CRUSCOTTO	DASHBOARD	TABLEAU DE BORD	KONSOLE
18	125943010/0	2	VITE	SCREW	VIS	SCHRAUBE
19	325260003/0	2	GOMMINO	GROMMET	PROTECTION	SCHUTZ
20	325600080/0	1	PROTEZIONE SCHEDA	CARD PROTECTION	PROTECTION DE CARTE	KARTESCHUTZ
21	325120203/0	1	COPERCHIO	COVER	COUVERCLE	DECKEL
22	325961219/0	1	VOLANTE	STEERING WHEEL	VOLANT	LENKRAD
23A	325580503/0	1	PLACCA VOLANTE	STEERING PLATE	PLAQUE VOLANT	LENKRADPLATTE
23B	325580504/0	1	PLACCA VOLANTE	STEERING PLATE	PLAQUE VOLANT	LENKRADPLATTE
25	325110398/0	1	COPERTURA CENTRALE, GRIGIO	COVER, GREY	COUVRE, GRIS	KAPPE, GRAU
25	325110383/0	1	COPERTURA CENTRALE, ROSSO	COVER, RED	COUVRE, ROUGE	KAPPE, ROT
25	325110396/0	1	COPERTURA CENTRALE, GIALLO	COVER, YELLOW	COUVRE, JAUNE	KAPPE, GELB
26	125943010/0	1	VITE	SCREW	VIS	SCHRAUBE
33	112735406/0	4	VITE	SCREW	VIS	SCHRAUBE
34	325110382/0	1	COPERTURA RUOTE, ROSSO	WHEELS COVER, RED	COUVRE-ROUES, ROUGE	RADENKAPPE, ROT
34	325110399/0	1	COPERTURA RUOTE, GIALLO	WHEELS COVER, YELLOW	COUVRE-ROUES, JAUNE	RADENKAPPE, GELB
34	325110401/0	1	COPERTURA RUOTE, GRIGIO	WHEELS COVER, GREY	COUVRE ROUES, GRIS	RADENKAPPE, GRAU





N.	CODE	Q.TY	DESCRIZIONE	DESCRIPTION	DESCRIPTION	BESCHREIBUNG
35	112437506/0	1	PIASTRINA	PLATE	PLAQUE	PLATTE
36	125943010/0	2	VITE	SCREW	VIS	SCHRAUBE
37	112735406/0	2	VITE	SCREW	VIS	SCHRAUBE
38	12523040/0	2	ROSETTA	WASHER	RONDELLE	SCHEIBE
39	325547208/0	1	PIASTRA	PLATE	PLAQUE	PLATTE
40	125943010/0	2	VITE	SCREW	VIS	SCHRAUBE
41	25722463/0	1	SEDILE	SEAT	SIEGE	SITZ
42	325110384/0	1	COPRIPEDANA DESTRA	RIGHT FOOTBOARDCOVER	COUVRE MARCHEPIED DRO.	RECHTE FUSSBRETTDECKEL
43	325110385/0	1	COPRIPEDANA SINISTRA	LEFT FOOTBOARD COVER	COUVRE MARCHEPIED GAU.	LINKE FUSSBRETTDECKEL
45	12792611/0	4	VITE	SCREW	VIS	SCHRAUBE
46	12540260/0	4	GROWER	GROWER	GROWER	GROWER
47	12523060/0	4	RONDELLA	WASHER	RONDELLE	SCHEIBE
51	125722472/0	1	SEDILE	SEAT	SIEGE	SITZ



# SD98

www.ersatzteil-seite.de  
**STERZO**  
**STEERING**  
**BARRE DE DIRECTION**  
**LENKGETRIEBE**

2009

**5103.0**

1 / 2

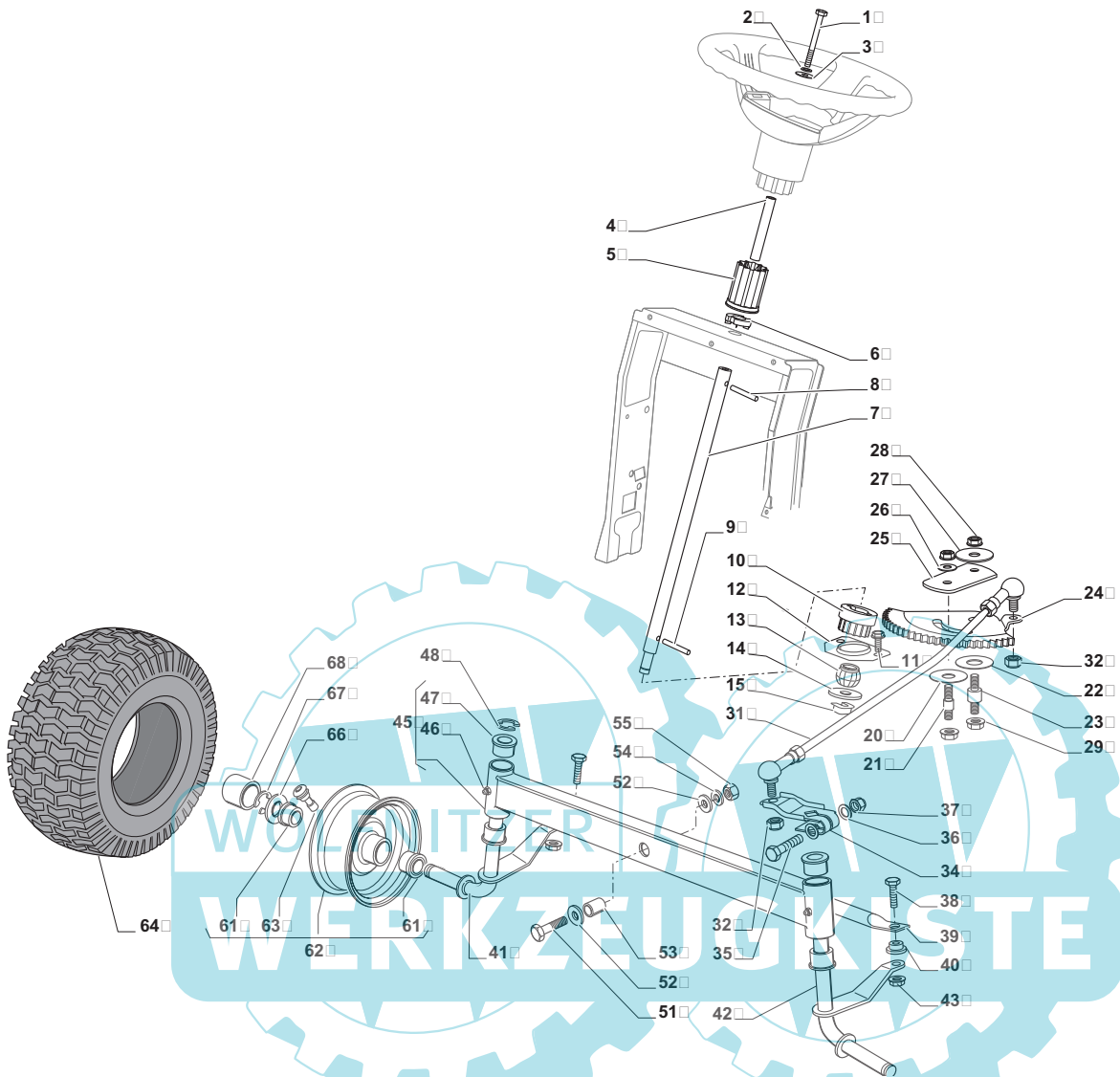

N.	CODE	Q.TY	DESCRIZIONE	DESCRIPTION	DESCRIPTION	BESCHREIBUNG
----	------	------	-------------	-------------	-------------	--------------

1	12692050/0	1	VITE	SCREW	VIS	SCHRAUBE
2	12540260/0	1	ROSETTA	WASHER	RONDELLE	SCHEIBE
3	12523070/0	1	ROSETTA	WASHER	RONDELLE	SCHEIBE
4	125160047/0	1	DISTANZIALE	SPACER	ENTRETOISE	ENTFERNUNGSSTÜCK
5	325785318/0	1	SUPPORTO	SUPPORT	SUPPORT	HALTER
6	325038008/0	1	BOCCOLA	BUSH	DOUILLE	BÜCHSE
7	125520007/0	1	PIANTONE	STEERING COLUMN	TUBE DE DIRECTION	LENKUNGSÄULE
8	112620300/0	1	SPINA	PIN	GOUPILLE	STIFT
9	12622650/0	1	SPINA	PIN	GOUPILLE	STIFT
10	125570003/0	1	PIGNONE	PINION	PIGNON	RITZEL
11	27943051/0	2	VITE	SCREW	VIS	SCHRAUBE
12	25785213/0	1	SUPPORTO	SUPPORT	SUPPORT	HALTER
13	25743000/0	1	SNODO	JOINT	JOINT	GELENK
14	12521370/0	1	ROSETTA	WASHER	RONDELLE	SCHEIBE
15	12436030/0	1	PERNO	PIN	PIVOT	BOLZEN
20	22672151/0	1	RONDELLA	WASHER	RONDELLE	SCHEIBE
21	125510104/0	1	PERNO	PIN	PIVOT	BOLZEN
22	125670023/0	1	RONDELLA	WASHER	RONDELLE	SCHEIBE
23	125510109/0	1	PERNO	PIN	PIVOT	BOLZEN
24	325735519/0	1	SETTORE	STEERING SHAFT	ARBRE DIRECTION	LENKUNGSWELLE
25	325547233/0	1	PIASTRA	PLATE	PLAQUE	PLATTE
26	12369500/0	1	RONDELLA	WASHER	RONDELLE	SCHEIBE
27	22160400/0	1	DISCO ELASTICO	ELASTIC WASHER	DISQUE ELASTIQUE	FEDERSCHEIBE
28	12155010/0	2	DADO	NUT	ECROU	MUTTER
29	12293201/0	2	DADO	NUT	ECROU	MUTTER
31	382000566/0	1	ASTA COMANDO STERZO	STEERING ROD	BARRE DE DIRECTION	LENKUNGSSTAB
32	12156602/0	2	DADO	NUT	ECROU	MUTTER





N.	CODE	Q.TY	DESCRIZIONE	DESCRIPTION	DESCRIPTION	BESCHREIBUNG
34	325318243/0	1	LEVA COMANDO	LEVER	LEVIER	HEBEL
35	12692390/0	1	VITE	SCREW	VIS	SCHRAUBE
36	12521360/0	2	ROSETTA	WASHER	RONDELLE	SCHEIBE
37	12156602/0	1	DADO	NUT	ECROU	MUTTER
38	125510103/0	2	PERNO	PIN	PIVOT	BOLZEN
39	325840029/0	1	TIRANTE COLLEG. FUSELLI	TIE ROD	TIRANT	SPANNSTANGE
40	325038007/0	2	BOCCOLA	BUSH	DOUILLE	BÜCHSE
41	382230369/0	1	FUSELLO DESTRO 13"	RIGHT STUB AXLE 13"	FUSEAU DROITE 13"	RECHTER ACHSSCHENKEL 13"
41	382230373/0	1	FUSELLO DESTRO 15"	RIGHT STUB AXLE 15"	FUSEAU DROITE 15"	RECHTER ACHSSCHENKEL 15"
42	382230371/0	1	FUSELLO SINISTRO 13"	LEFT STUB AXLE 13"	FUSEAU GAUCHE 13"	LINKER ACHSSCHENKEL 13"
42	382230375/0	1	FUSELLO SINISTRO 15"	LEFT STUB AXLE 15"	FUSEAU GAUCHE 15"	LINKER ACHSSCHENKEL 15"
43	12155000/0	2	DADO	NUT	ECROU	MUTTER
45	382034030/0	1	BILANCIERE CON BOCCOLA ED INGRASSATORE 13"	EQUALIZER WITH BUSH AND LUBRICATOR	BALANCIER AVEC DOUILLE ET GRAISSEUR	KIPPHEBEL MIT BÜCHSE UND FETTBUCHSE
46	12379511/0	2	INGRASSATORE	GREASE DISPENSER	GRAISSEUR	FETTBUCHSE
47	25034002/1	4	BRONZINA	BUSH	DOUILLE	BÜCHSE
48	12001010/0	1	BENZING	BENZING	BENZING	BENZING
51	12692695/0	1	VITE	SCREW	VIS	SCHRAUBE
52	12523100/0	2	ROSETTA	WASHER	RONDELLE	SCHEIBE
53	25160016/0	1	DISTANZIALE	SPACER	ENTRETOISE	ENTFERNUNGSSTÜCK
54	12587100/0	1	ROSETTA	WASHER	RONDELLE	SCHEIBE
55	12295300/0	1	DADO	NUT	ECROU	MUTTER
61	25122200/2	4	CUSCINETTO	BEARING	ROULEMENT	KUEGELLAGER
62	182000598/0	2	CERCHIO RUOTA	RIMM	BANDAGE ROUE	VORDERRAD FELGER
63	25950000/0	2	VALVOLA	VALVE	SOUPAPE	VENTIL
64	125590014/0	2	PNEUMATICO 13"	TIRE 13"	PNEU 13"	REIFEN 13"
64	127590066/0	2	PNEUMATICO 15"	TIRE 15"	PNEU 15"	REIFEN 15"
66	25670005/1	2	RONDELLA	WASHER	RONDELLE	SCHEIBE
67	12001010/0	2	BENZING	BENZING	BENZING	BENZING
68	322110233/0	2	COPRIMOZZO	HUB COVER	COUVRE MOYEU	NABEDECKEL

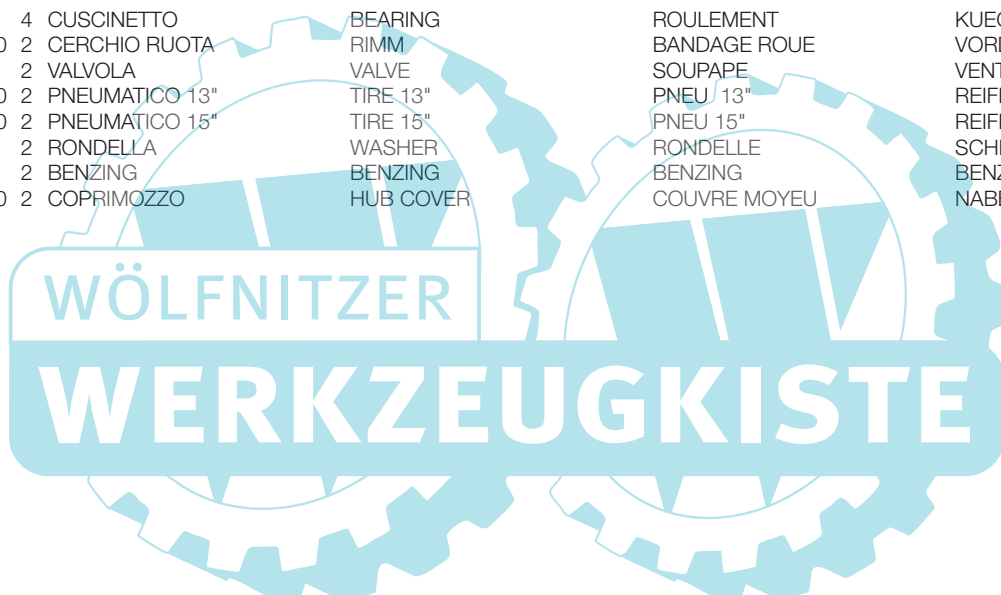

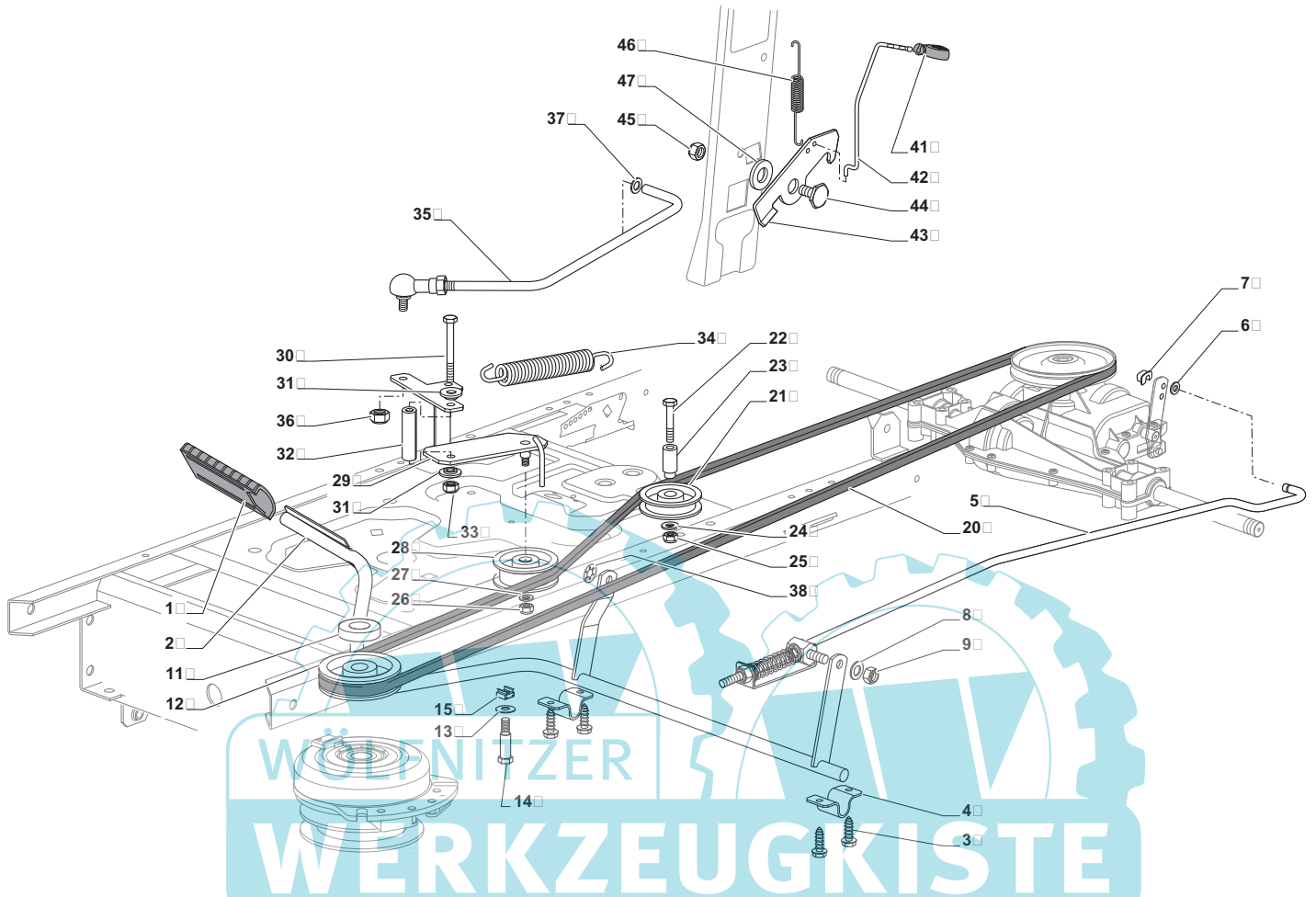

N.	CODE	Q.TY	DESCRIZIONE	DESCRIPTION	DESCRIPTION	BESCHREIBUNG
1	325110391/0	1	COPRISTAFFA	CLAMP COVER	COUVRE ETRIER	BRIDEDECKEL
2	382500033/0	1	PEDALE	PEDAL	PEDAL	PEDAL
3	12735599/0	4	VITE	SCREW	VIS	SCHRAUBE
4	325547231/0	2	PIASTRA	PLATE	PLAQUE	PLATTE
5	382000568/0	1	ASTA	ROD	BARRE	STANGE
6	12521350/0	1	ROSETTA	WASHER	RONDELLE	SCHEIBE
7	12436050/0	1	PIASTRINA	PLATE	PLAQUE	PLATTE
8	25670011/0	1	ROSETTA	WASHER	RONDELLE	SCHEIBE
9	12155000/0	1	DADO	NUT	ECROU	MUTTER
11	25160021/0	1	DISTANZIALE	SPACER	ENTRETOISE	ENTFERNUNGSSTÜCK
12	25601567/0	1	PULEGGIA	PULLEY	POULIE	RIEMENSCHLEIBE
13	12524010/0	2	ROSETTA	WASHER	RONDELLE	SCHEIBE
14	25580018/0	2	GUIDACINGHIA	BELT GUIDE	GUIDE DE COURROIRE	RIEMENFÜHRUNG
15	12360425/0	2	DADO	NUT	ECROU	MUTTER
20	135062013/0	1	CINGHIA	BELT	COURROIE	RIEMEN
21	25601555/0	1	PULEGGIA	PULLEY	POULIE	RIEMENSCHLEIBE
22	12691400/0	1	VITE	SCREW	VIS	SCHRAUBE
23	125160051/0	1	DISTANZIALE	SPACER	ENTRETOISE	ENTFERNUNGSSTÜCK
24	12523060/0	1	ROSETTA	WASHER	RONDELLE	SCHEIBE
25	12155000/0	1	DADO	NUT	ECROU	MUTTER
26	12155000/0	1	DADO	NUT	ECROU	MUTTER
27	12523060/0	1	ROSETTA	WASHER	RONDELLE	SCHEIBE
28	25601554/0	1	PULEGGIA	PULLEY	POULIE	RIEMENSCHLEIBE
29	382318235/0	1	LEVA	LEVER	LEVIER	HEBEL
30	12691600/0	1	VITE	SCREW	VIS	SCHRAUBE
31	25038002/1	2	BOCCOLA	BUSH	DOUILLE	BÜCHSE
32	25160027/0	1	DISTANZIALE	SPACER	ENTRETOISE	ENTFERNUNGSSTÜCK
33	12155000/0	1	DADO	NUT	ECROU	MUTTER
34	125430262/0	1	MOLLA	SPRING	RESSORT	FEDER
35	382820016/0	1	ASS. TIRANTE	TIE ROD ASS.Y	ENS. TIRANT	SPANNSTANGE, KOMPLETT



N.	CODE	Q.TY	DESCRIZIONE	DESCRIPTION	DESCRIPTION	BESCHREIBUNG
36	12293201/0	1	DADO	NUT	ECROU	MUTTER
37	12521350/0	1	ROSETTA	WASHER	RONDELLE	SCHEIBE
38	12604899/0	1	FISSATORE A CORONA	CROWN FASTENER	FIXATEUR A COURONNE	KRONESCHEIBE
41	325394534/0	1	MANOPOLINA	KNOB	POIGNEE	GRIFF
42	125033083/0	1	ASTA	ROD	BARRE	STANGE
43	325253011/0	1	GANCIO	HOOK	CROCHET	HAKEN
44	22524970/2	1	PERNO	PIN	PIVOT	BOLZEN
45	12155000/0	1	DADO	NUT	ECROU	MUTTER
46	25430213/0	1	MOLLA	SPRING	RESSORT	FEDER
47	12523060/0	1	ROSETTA	WASHER	RONDELLE	SCHEIBE

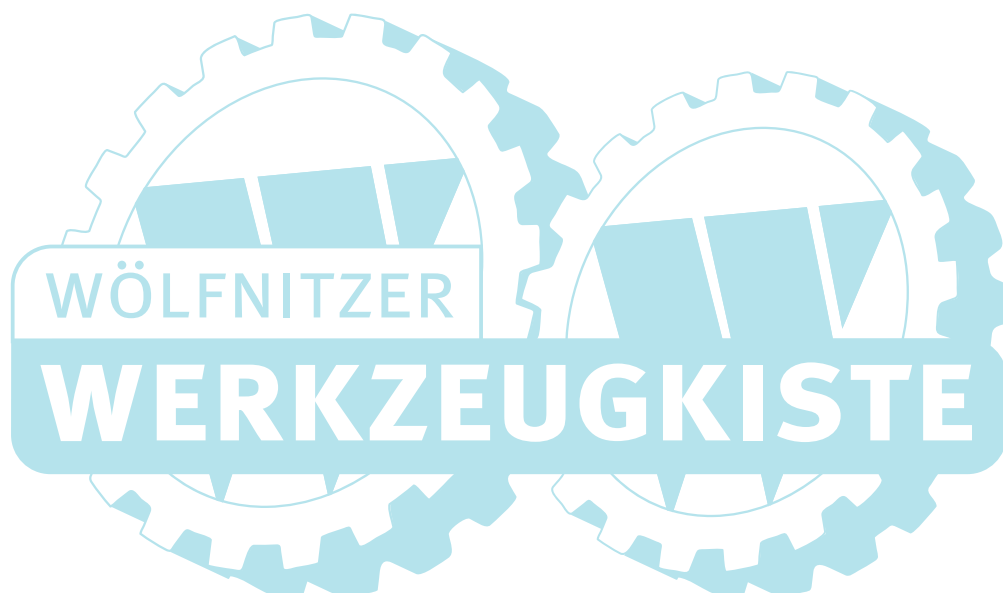



# SD98

www.ersatzteil-service.de  
**TRASMISSIONE**  
**TRANSMISSION**  
**TRANSMISSION**  
**GETRIEBE**

2009

5105.0

1 / 2

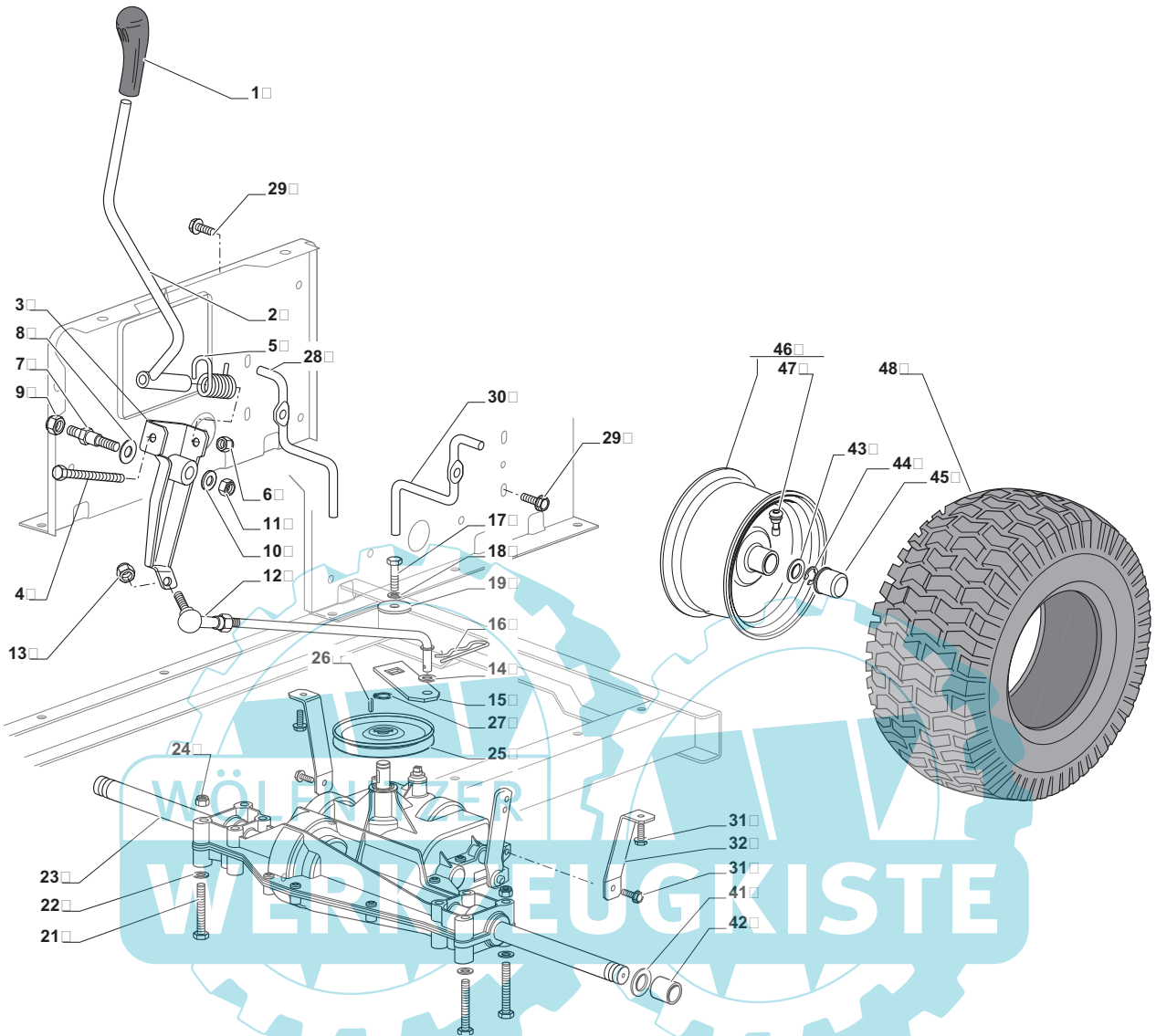

N.	CODE	Q.TY	DESCRIZIONE	DESCRIPTION	DESCRIPTION	BESCHREIBUNG
----	------	------	-------------	-------------	-------------	--------------

1	325394532/0	1	MANOPOLA	KNOB	POIGNEE	GRIF
2	382318233/0	1	LEVA	LEVER	LEVIER	HEBEL
3	382774259/0	1	STAFFA	CLAMP	ETRIER	BRIDE
4	12692050/0	1	VITE	SCREW	VIS	SCHRAUBE
5	25430226/0	1	MOLLA	SPRING	RESSORT	FEDER
6	12155000/0	1	DADO	NUT	ECROU	MUTTER
7	25510035/0	1	PERNO	PIN	PIVOT	BOLZEN
8	22672151/0	1	RONDELLA	WASHER	RONDELLE	SCHEIBE
9	12293201/0	1	DADO	NUT	ECROU	MUTTER
10	12523060/0	1	ROSETTA	WASHER	RONDELLE	SCHEIBE
11	12155010/0	1	DADO	NUT	ECROU	MUTTER
12	382000567/0	1	ASTA	ROD	BARRE	STANGE
13	12293201/0	1	DADO	NUT	ECROU	MUTTER
14	12521340/0	1	ROSETTA	WASHER	RONDELLE	SCHEIBE
15	325318235/0	1	LEVA	LEVER	LEVIER	HEBEL
16	12141418/0	1	COPPIGLIA	COTTER PIN	GOUPILLE	SPLIT
17	12735520/0	1	VITE	SCREW	VIS	SCHRAUBE
18	12540040/0	1	ROSETTA	WASHER	RONDELLE	SCHEIBE
19	22680009/0	1	ROSETTA	WASHER	RONDELLE	SCHEIBE
21	12691600/0	4	VITE	SCREW	VIS	SCHRAUBE
22	12521350/0	4	ROSETTA	WASHER	RONDELLE	SCHEIBE
23	18400912/0	1	ASSE POST. DANA 4360-211	REAR AXLE DANA 4360-211	AXE ARRIERE DANA 4360-211	HINTERACHSE DANA 4360-211
24	12155000/0	4	DADO	NUT	ECROU	MUTTER
25	82601509/0	1	PULEGGIA	PULLEY	POULIE	RIEMENSCHIEBE
26	12139430/0	1	LINGUETTA	FEATHER	CLAVETTE	KEIL
27	12608950/0	1	SEEGER	SEEGER	SEEGER	SEEGER
28	125270329/0	1	GUIDACINGHIA	BELT GUIDE	GUIDE DE COURROIE	RIEMENFÜHRUNG





N.	CODE	Q.TY	DESCRIZIONE	DESCRIPTION	DESCRIPTION	BESCHREIBUNG
29	12735599/0	2	VITE	SCREW	VIS	SCHRAUBE
30	125270330/0	1	GUIDACINGHIA	BELT GUIDE	GUIDE DE COURROIRE	RIEMENFÜHRUNG
31	125493009/0	4	VITE	SCREW	VIS	SCHRAUBE
32	325785315/0	2	SUPPORTO	SUPPORT	SUPPORT	HALTER
41	25670005/1	2	RONDELLA	WASHER	RONDELLE	SCHEIBE
42	125160055/0	2	DISTANZIALE	SPACER	ENTRETOISE	ENTFERNUNGSSTÜCK
43	25670005/1	6	RONDELLA	WASHER	RONDELLE	SCHEIBE
44	12001010/0	2	BENZING	BENZING	BENZING	BENZING
45	322110233/0	2	COPRIMOZZO	HUB COVER	COUVRE MOYEU	NABEDECKEL
46	382000597/0	2	CERCHIO RUOTA	RIMM	BANDAGE ROUE	HINTRERRAD FELGER
47	25950000/0	2	VALVOLA	VALVE	SOUPAPE	VENTIL
48	125590015/0	2	PNEUMATICO KENDA	SHOE KENDA	PNEU KENDA	REIFEN KENDA

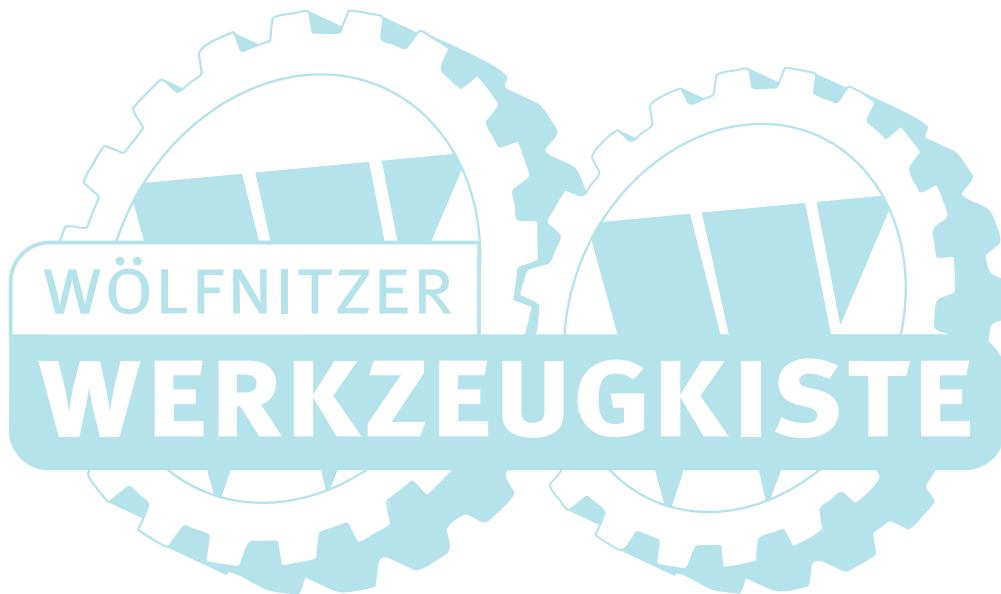

# SD98

www.ersatzteil-secuto.de



SOLLEVAMENTO PIATTO DI TAGLIO  
CUTTING PLATE LIFTING  
SOULEVEMENT PLATEAU DE COUPE  
SCHNEIDWERKZEUG AUFHEBESATZ

2009

5106.0

1 / 2

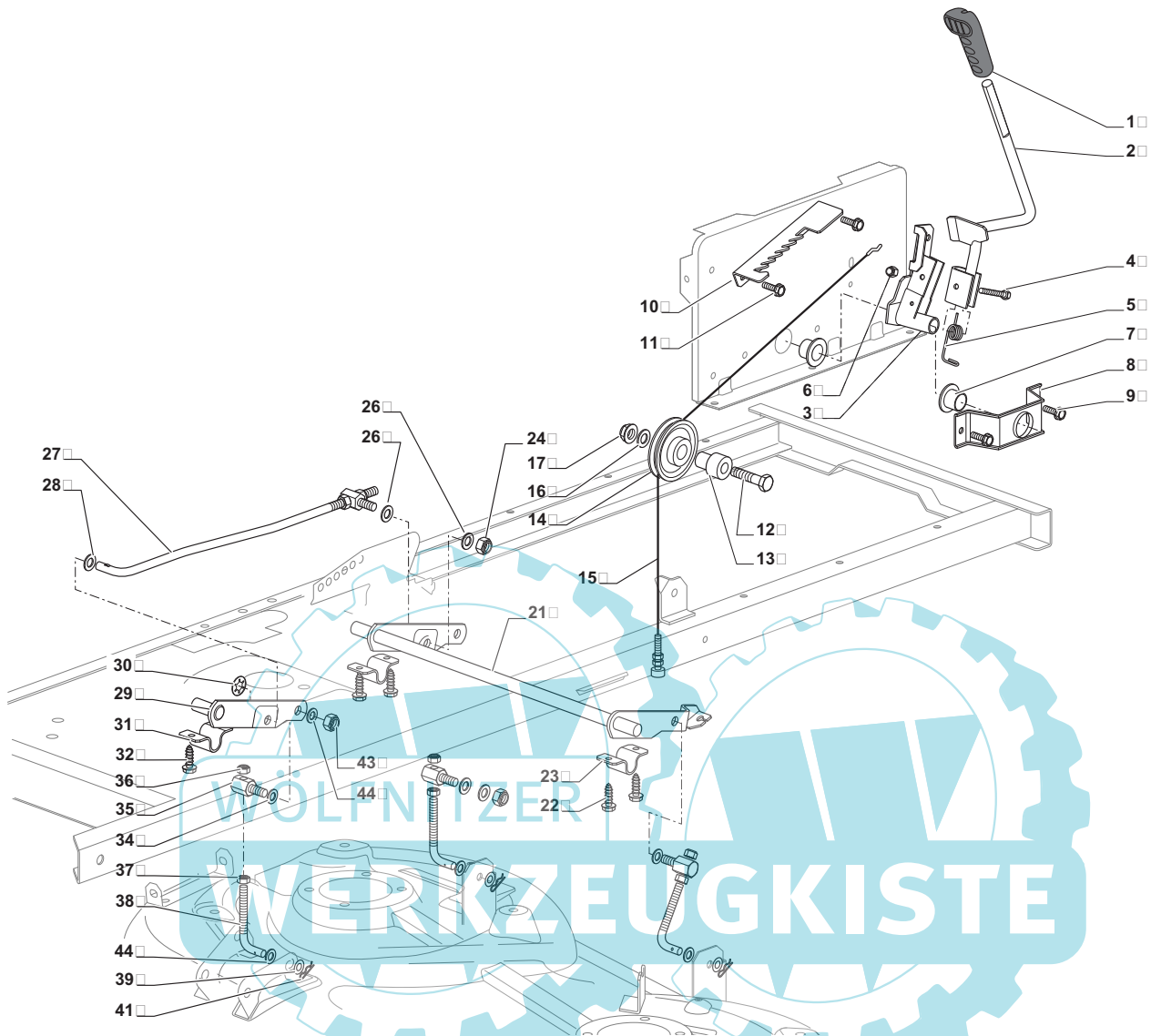

N.	CODE	Q.TY	DESCRIZIONE	DESCRIPTION	DESCRIPTION	BESCHREIBUNG
1	325394533/0	1	MANOPOLA	KNOB	POIGNEE	GRIF
2	382318229/0	1	LEVA	LEVER	LEVIER	HEBEL
3	382318231/0	1	ASSE SOLLEVAMENTO	AXLE	AXE	ACHSE
4	12674700/0	1	VITE	SCREW	VIS	SCHRAUBE
5	125430261/0	1	MOLLA	SPRING	RESSORT	FEDER
6	12154510/0	1	DADO	NUT	ECROU	MUTTER
7	325038006/0	2	BOCCOLA	BUSH	DOUILLE	BÜCHSE
8	325785297/0	1	SUPPORTO	SUPPORT	SUPPORT	HALTER
9	125943009/0	2	VITE	SCREW	VIS	SCHRAUBE
10	325735515/0	1	SETTORE	STEERING SHAFT	ARBRE DIRECTION	LENKUNGSWELLE
11	125943009/0	2	VITE	SCREW	VIS	SCHRAUBE
12	12793701/0	1	VITE	SCREW	VIS	SCHRAUBE
13	125040636/0	1	BUSSOLA	BUSH	DOUILLE	BÜCHSE
14	125601579/0	1	PULEGGIA	PULLEY	POULIE	RIEMENSCHIEBE
15	382004620/0	1	FILO	WIRE	FIL	KABEL
16	12523060/0	1	ROSETTA	WASHER	RONDELLE	SCHEIBE
17	12293201/0	1	DADO	NUT	ECROU	MUTTER
21	382318239/0	1	ASSE SOLLEVAMENTO	AXLE	AXE	ACHSE
22	12735599/0	4	VITE	SCREW	VIS	SCHRAUBE
23	325547231/0	2	PIASTRA	PLATE	PLAQUE	PLATTE
24	12155000/0	1	DADO	NUT	ECROU	MUTTER
26	25670011/0	2	RONDELLA	WASHER	RONDELLE	SCHEIBE
27	382000569/0	1	ASTA COLLEGAMENTO	CONNECTING ROD	TIGE DE CONNEXION	VERBINDUNGSSTAB
28	12521350/0	1	RONDELLA	WASHER	RONDELLE	SCHEIBE
29	382318237/0	1	ASSE SOLLEVAMENTO	AXLE	AXE	ACHSE





N.	CODE	Q.TY	DESCRIZIONE	DESCRIPTION	DESCRIPTION	BESCHREIBUNG
30	12604899/0	1	FISSATORE A CORONA	CROWN FASTENER	FIXATEUR A COURONNE	KRONESCHEIBE
31	325547231/0	1	PIASTRA	PLATE	PLAQUE	PLATTE
32	12735599/0	2	VITE	SCREW	VIS	SCHRAUBE
34	25670008/1	3	RONDELLA	WASHER	RONDELLE	SCHEIBE
35	125510107/1	3	PERNO	PIN	PIVOT	BOLZEN
36	12156602/0	3	DADO	NUT	ECROU	MUTTER
37	12295200/0	3	DADO	NUT	ECROU	MUTTER
38	25840012/0	3	TIRANTE	TIE ROD	TIRANT	SPANNSTANGE
39	12523060/0	3	ROSETTA	WASHER	RONDELLE	SCHEIBE
41	24487998/0	3	COPPIGLIA	COTTER PIN	GOUPILLE	SPLIT
43	12156602/0	3	DADO	NUT	ECROU	MUTTER
44	25670008/1	6	RONDELLA	WASHER	RONDELLE	SCHEIBE



# SD98

www.ersatzteil-service.de

PIATTO DI TAGLIO (1)  
CUTTING PLATE (1)  
PLATEAU DE COUPE (1)  
SCHNEIDWERKZEUG (1)

2009

5107.0

1 / 2

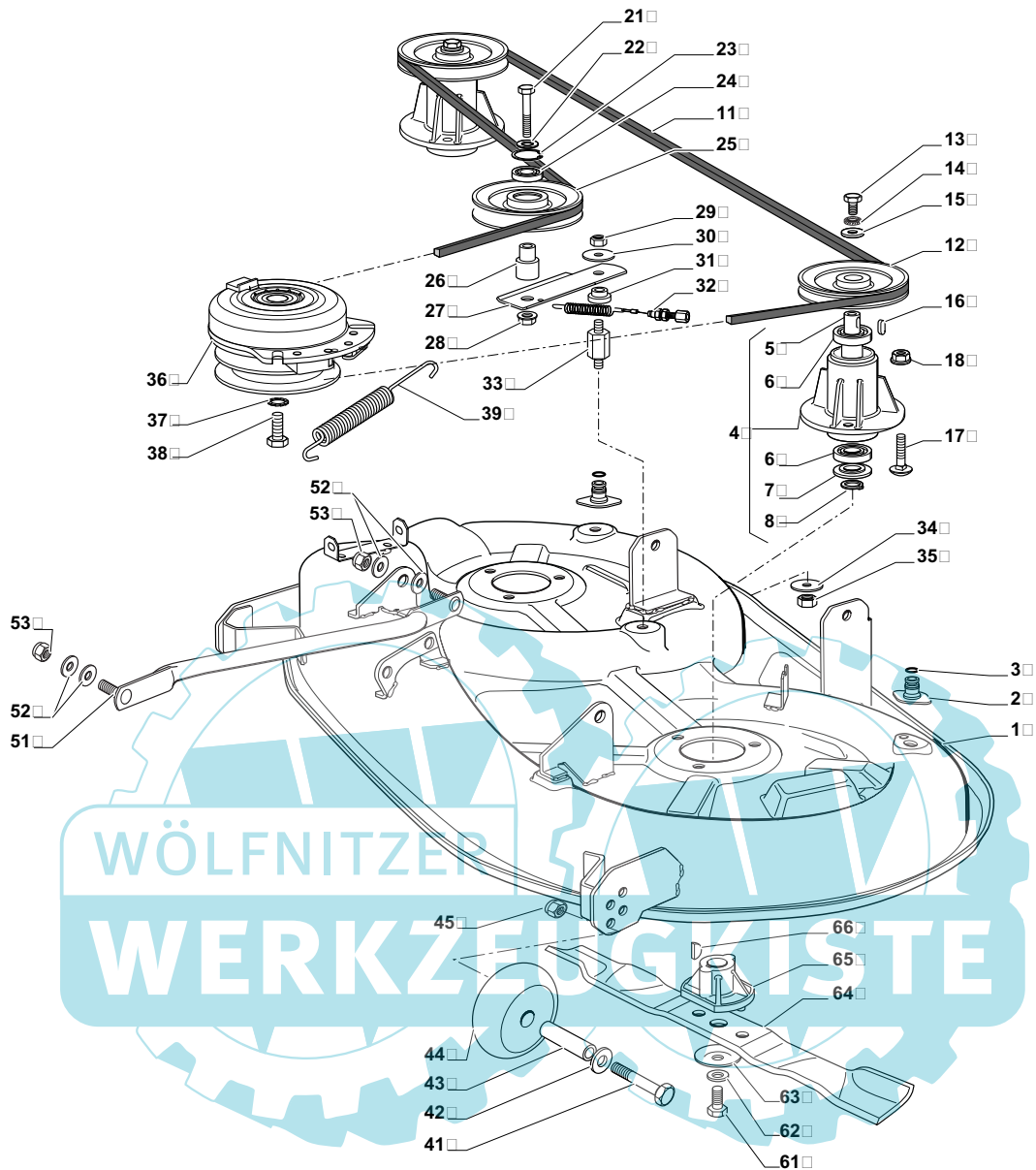

N.	CODE	Q.TY	DESCRIZIONE	DESCRIPTION	DESCRIPTION	BESCHREIBUNG
1	382564209/0	1	PIATTO, NERO	PLATE	PLATEAU	SCHNEID
2	325033086/0	2	ATTACCO TUBO ACQUA	WATER HOSE CONNECTION	RACCORD TUYAU D'EAU	WASSERANSCHLUSS
3	19035000/0	2	ANELLO OR	O RING	O RING	O RING
4	382207204/0	2	ASS. FLANGIA	FLANGE ASS.Y	ENSAMBLE BRIDE	NABE, KOMPLETT
5	125020804/0	2	ALBERO	SHAFT	ARBRE	WELLE
6	19216040/0	4	CUSCINETTO	BEARING	ROULEMENT	KUEGELLAGER
7	25160501/0	2	DISCO PARAPOLVERE	DUST COVER	PROTEGE-POUSSIERE	STAUBSCHUTTSCHIEBE
8	12609260/0	2	SEEGER	SEEGER	SEEGER	SEEGER
11	135061504/0	1	CINGHIA	BELT	COURROIE	RIEMEN
12	25601571/0	2	PULEGGIA	PULLEY	POULIE	RIEMENSCHIEBE
13	12793102/0	2	VITE	SCREW	VIS	SCHRAUBE
14	12540260/0	2	RONDELLA	WASHER	RONDELLE	SCHEIBE
15	25670007/0	2	RONDELLA	WASHER	RONDELLE	SCHEIBE
16	12139480/0	2	LINGUETTA	FEATHER	CLAVETTE	KEIL
17	12818690/0	6	VITE	SCREW	VIS	SCHRAUBE
18	12154210/0	6	DADO	NUT	ECROU	MUTTER
21	12691400/0	1	VITE	SCREW	VIS	SCHRAUBE
22	12524010/0	1	RONDELLA	WASHER	RONDELLE	SCHEIBE
23	12610800/0	1	SEEGER	SEEGER	SEEGER	SEEGER
24	19216041/0	1	CUSCINETTO	BEARING	ROULEMENT	KUEGELLAGER
25	125601586/0	1	PULEGGIA	PULLEY	POULIE	RIEMENSCHIEBE





N.	CODE	Q.TY	DESCRIZIONE	DESCRIPTION	DESCRIPTION	BESCHREIBUNG
26	125160052/0	1	DISTANZIALE	SPACER	ENTRETOISE	ENTFERNUNGSSTÜCK
27	325318232/0	1	LEVA	LEVER	LEVIER	HEBEL
28	12293201/0	1	DADO	NUT	ECROU	MUTTER
29	12155020/0	1	DADO	NUT	ECROU	MUTTER
30	125670022/0	1	RONDELLA	WASHER	RONDELLE	SCHEIBE
31	125040635/0	1	BUSSOLA	BUSH	DOUILLE	BÜCHSE
32	82004618/0	1	FILO	WIRE	FIL	KABEL
33	125160049/0	1	DISTANZIALE	SPACER	ENTRETOISE	ENTFERNUNGSSTÜCK
34	12523080/0	1	ROSETTA	WASHER	RONDELLE	SCHEIBE
35	12156602/0	1	DADO	NUT	ECROU	MUTTER
36	118399063/0	1	FRIZIONE	CLUTCH	EMBRAJAGE	KUPPLUNG
37	12543000/0	1	ROSETTA	WASHER	RONDELLE	SCHEIBE
38	12737320/0	1	VITE	SCREW	VIS	SCHRAUBE
39	22430216/0	1	MOLLA	SPRING	RESSORT	FEDER
41	12692050/0	2	VITE	SCREW	VIS	SCHRAUBE
42	12523060/0	2	ROSETTA	WASHER	RONDELLE	SCHEIBE
43	25510072/0	2	DISTANZIALE	SPACER	ENTRETOISE	ENTFERNUNGSSTÜCK
44	82700001/0	2	RUOTINO ANTISCALPO Ø 100	ANTI SCALP WHEEL Ø 100	ROULETTES ANTISCALP Ø 100	SKALPIERSCHUTZRÄDCHEN Ø 100
45	12293201/0	2	DADO	NUT	ECROU	MUTTER
51	382000565/0	2	ASTA BILANCIERE	EQUALIZER ROD	TIGE BALANCIER	KIPPHEBEL
52	25670008/1	8	RONDELLA	WASHER	RONDELLE	SCHEIBE
53	12156602/0	4	DADO	NUT	ECROU	MUTTER
61	12735694/0	2	VITE	SCREW	VIS	SCHRAUBE
62	12523080/0	2	ROSETTA	WASHER	RONDELLE	SCHEIBE
63	22160400/0	2	DISCO ELASTICO	ELASTIC WASHER	DISQUE ELASTIQUE	FEDERSCHEIBE
64	82004346/0	2	COLTELLO MULCHING	RIGHT BLADE MULCHING	LAME DROITE MULCHING	RECHTER MESSER MULCHING
65	25463200/0	2	MOZZO COLTELLO	BLADE HUB	MOYEU LAME	MESSERHALTER
66	12139100/0	2	LINGUETTA	FEATHER	CLAVETTE	KEIL

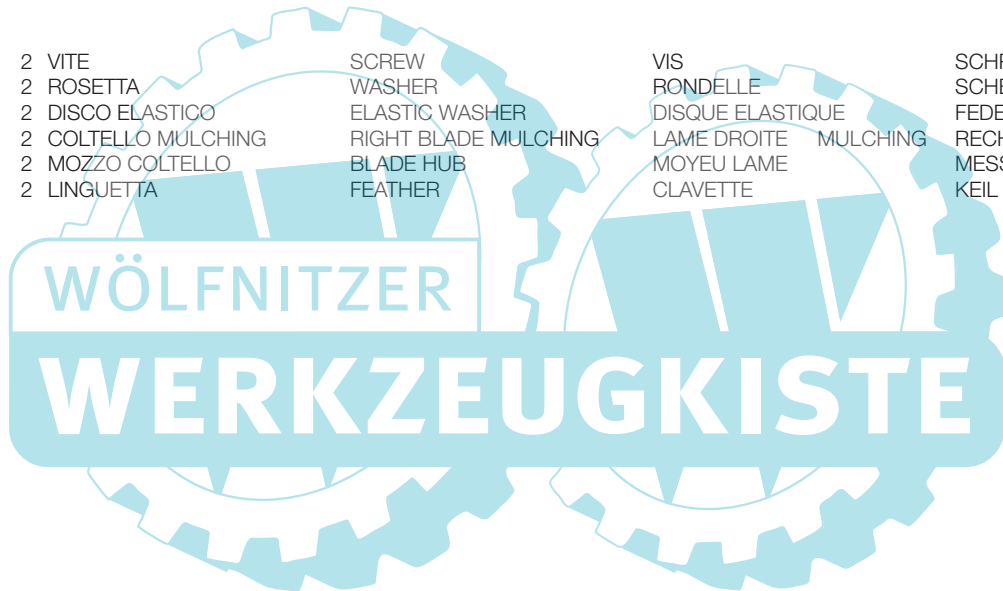

# SD98

[www.ersatzteil-seite.de](http://www.ersatzteil-seite.de)

PIATTO DI TAGLIO (2)  
CUTTING PLATE (2)  
PLATEAU DE COUPE (2)  
SCHNEIDWERKZEUG (2)

2009

5108.0

1 / 1

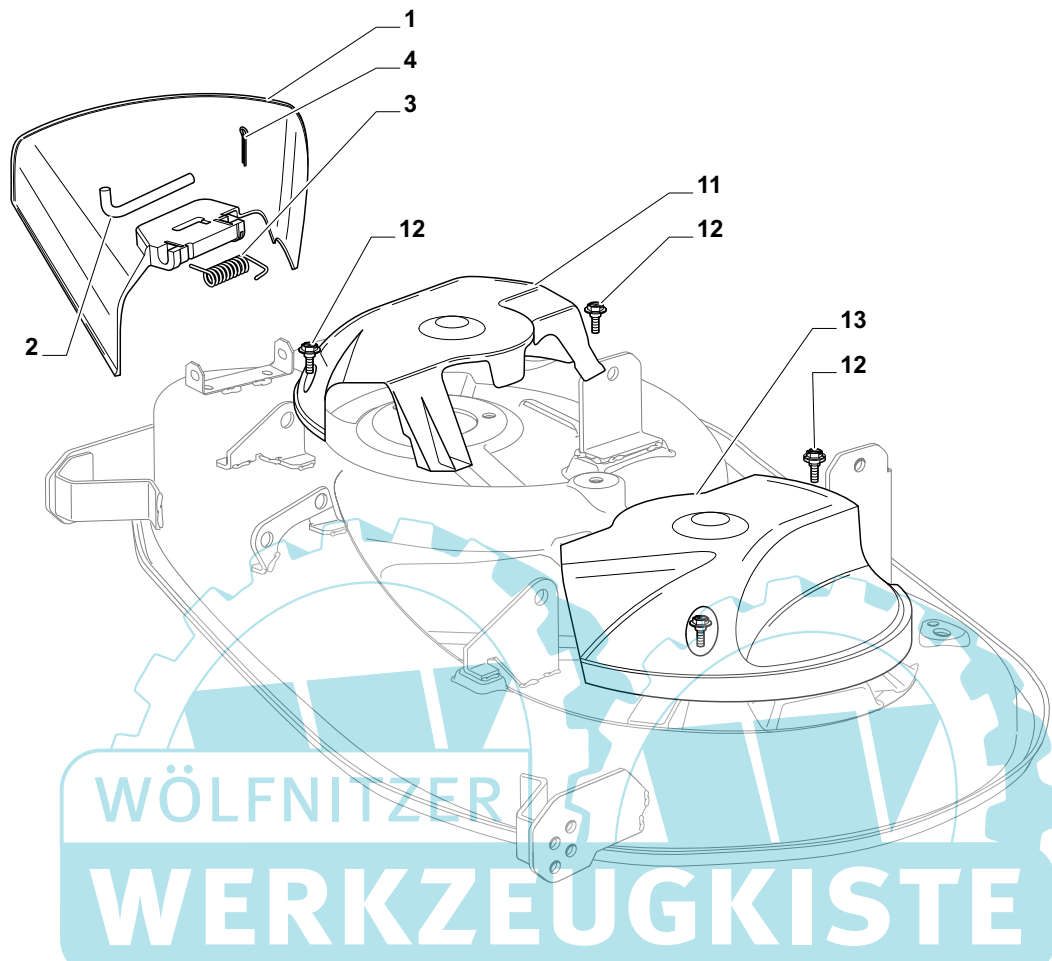

WÖLFNITZER  
WERKZEUGKISTE

N.	CODE	Q.TY	DESCRIZIONE	DESCRIPTION	DESCRIPTION	BESCHREIBUNG
1	325600077/0	1	PROTEZIONE USCITA	EXIT PROTECTION	PROTECTION EN SORTIE	AUSWURFSCHUTZ
2	125943010/0	1	PERNO	PIN	PIVOT	BOLZEN
3	25430242/0	1	MOLLA	SPRING	RESSORT	FEDER
4	12141418/0	1	COPPIGLIA	COTTER PIN	GOUPILLE	SPLIT
11	325600078/0	1	CARTER	CASE	CARTER	BLECH
12	125943006/0	4	VITE	SCREW	VIS	SCHRAUBE
13	325600079/0	1	CARTER	CASE	CARTER	BLECH





WÖLNITZER  
**WERKZEUCKISTE**

**USARE SOLO RICAMBI ORIGINALI!**  
**USE ONLY GENUINE SPARE PARTS!**  
**UTILISER DES PIÈCES DE RECHANGE D'ORIGINE!**  
**NUR ORIGINALERSATZTEILE VERWENDEN!**



# SD98

www.ersatzteil-service.de

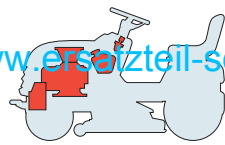

**MOTORE E SERBATOIO**  
**ENGINE AND FUEL TANK**  
**MOTEUR ET RESERVOIR**  
**MOTOR UND TANK**  
**GGP**

2009

5109.0

1 / 1

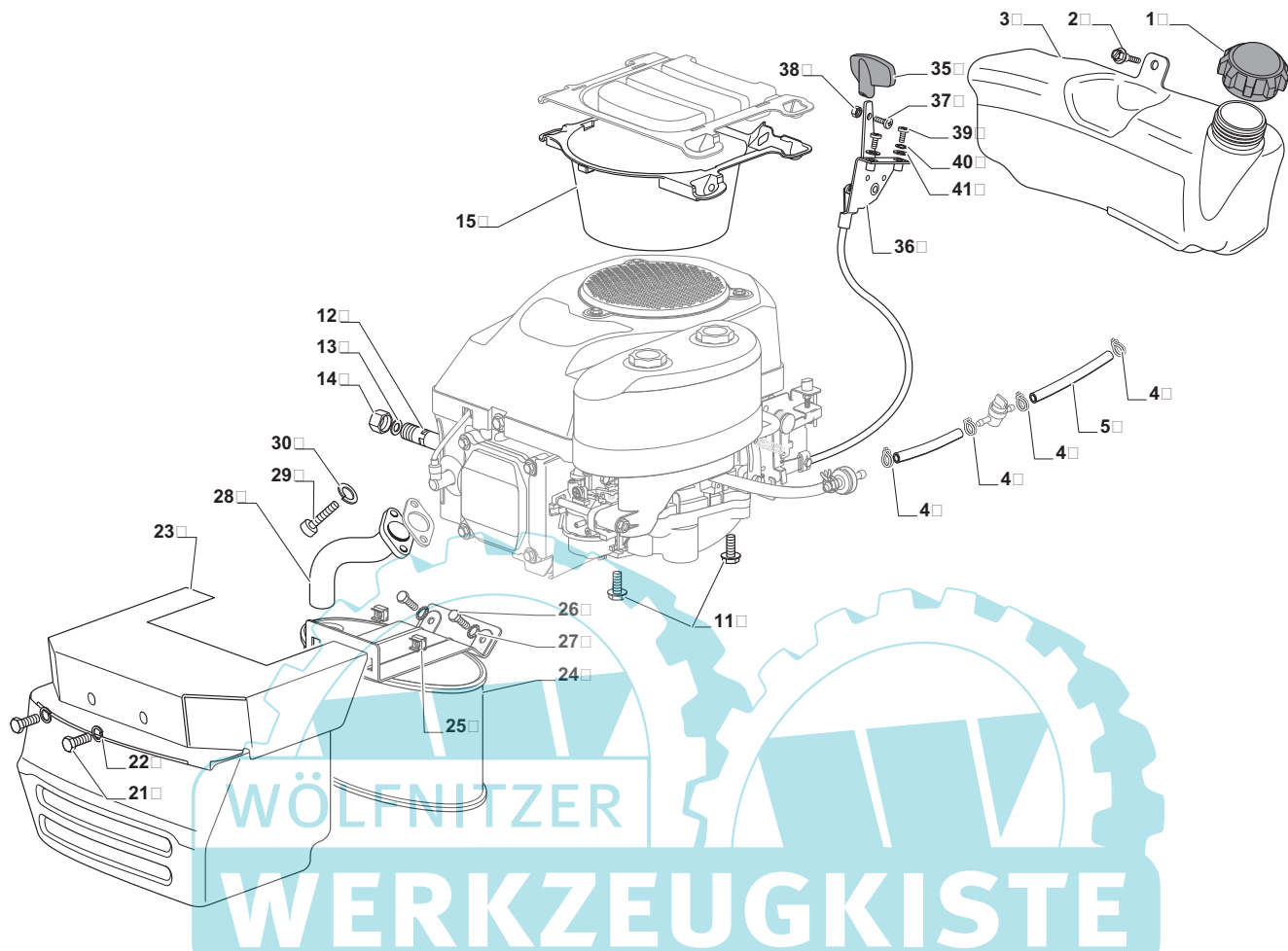

WÖLFNITZER  
**WERKZEUGKISTE**

N.	CODE	Q.TY	DESCRIZIONE	DESCRIPTION	DESCRIPTION	BESCHREIBUNG
1	25795001/1	1	TAPPO SERBATOIO	CAP	BOUCHON	TANKVERSCHLUSS
2	125943006/0	4	VITE	SCREW	VIS	SCHRAUBE
3	325735126/0	1	SERBATOIO	TANK	RESERVOIR	TANK
4	18375051/1	4	FASCETTA	FAIR LED	FIXATION DE CABLE	KABELBEFESTIGUNG
5	25869057/0	1	TUBO COLLEGAMENTO (1000 mm)	CONNECTING TUBE (1000 mm)	TUBE DE CONNEXION (1000 mm)	VERBINDUNGSRÖHR (1000 mm)
11	112735108/1	4	VITE	SCREW	VIS	SCHRAUBE
12	27598060/0	1	PROLUNGA SCARICO OLIO	OIL DISCHARGE EXTENSION	EXTENSION DECH. HUILE	ÖL ABFLUSS
13	18401001/1	1	GUARNIZIONE	OIL SEAL	GARNITURE	DICHTUNG
14	18737849/0	1	TAPPO PROLUNGA	OIL CAP	BOUCHON HUILE	OELVERSCHLUSS
15	325108044/0	1	CONVOGLIATORE	CONVEYOR	CONVOYEUR	KONVEYOR
21	12792611/0	2	VITE	SCREW	VIS	SCHRAUBE
22	12540260/0	2	ROSETTA	WASHER	RONDELLE	SCHEIBE
23	382598045/0	1	PROTEZIONE SILENZIATORE	MUFFLER PROTECTION	PROTECTION SILENCIEUX	AUSPUFFSCHUTZ
24	82750004/0	1	SILENZIATORE	MUFFLER	SILENCEUX	AUSPUFF
25	12360425/0	2	DADO	NUT	ECROU	MUTTER
26	12792611/0	2	VITE	SCREW	VIS	SCHRAUBE
27	12540260/0	2	ROSETTA	WASHER	RONDELLE	SCHEIBE
28	118738231/1	1	TUBO RACCORDO SCARICO	EXHAUST CONNECTING TUBE	TUBE DE CONNEXION ECHAPPEMENT	VERBINDUNGSRÖHR FÜR ABGASUNG
29	12737450/0	2	VITE	SCREW	VIS	SCHRAUBE
30	12540260/0	2	ROSETTA	WASHER	RONDELLE	SCHEIBE
35	325394531/0	1	MANOPOLINA	KNOB	POIGNEE	GRIFF
36	182000215/0	1	ACCELERATORE	ACCELERATOR	ACCELERATEUR	GAS ZUG
37	112726389/0	1	VITE	SCREW	VIS	SCHRAUBE
38	12290800/0	1	DADO	NUT	ECROU	MUTTER
39	112726389/0	2	VITE	SCREW	VIS	SCHRAUBE
40	12540020/0	2	ROSETTA	WASHER	RONDELLE	SCHEIBE
41	12521310/0	2	ROSETTA	WASHER	RONDELLE	SCHEIBE



# SD98

www.ersatzteil-service.de



**MOTORE E SERBATOIO**  
**ENGINE AND FUEL TANK**  
**MOTEUR ET RESERVOIR**  
**MOTOR UND TANK**  
**B&S**

2009

**5109a.0**

1 / 1

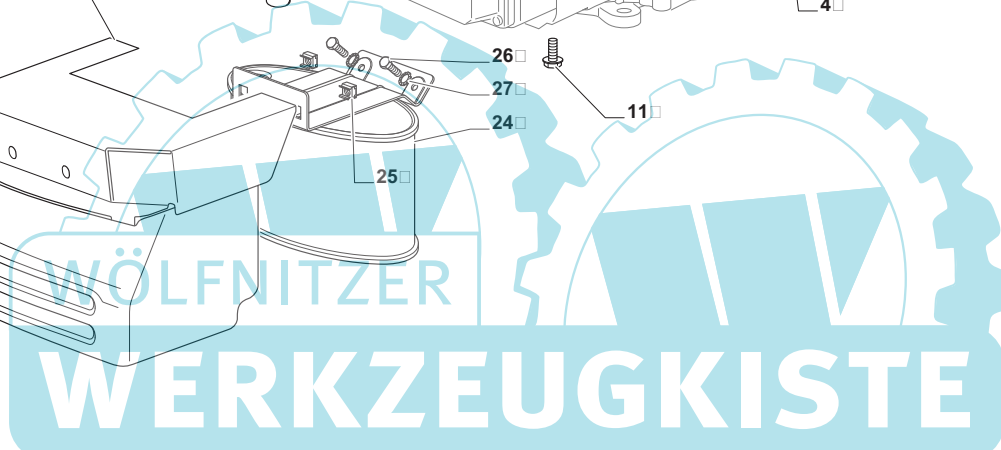
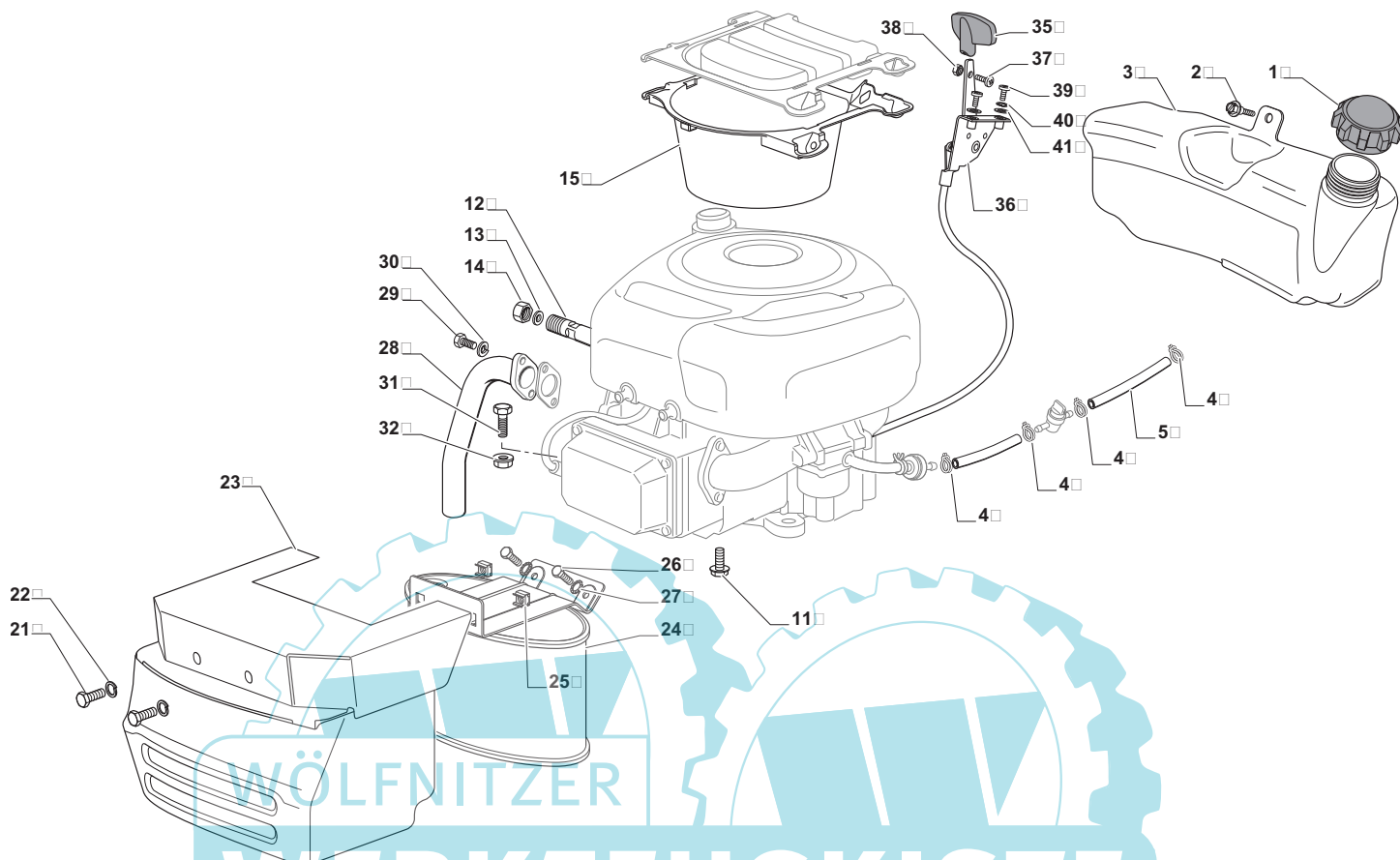

N.	CODE	Q.TY	DESCRIZIONE	DESCRIPTION	DESCRIPTION	BESCHREIBUNG
1	25795001/1	1	TAPPO SERBATOIO	CAP	BOUCHON	TANKVERSCHLUSS
2	125943010/0	4	VITE	SCREW	VIS	SCHRAUBE
3	325735126/0	1	SERBATOIO	TANK	RESERVOIR	TANK
4	18375051/1	4	FASCETTA	FAIR LED	FIXATION DE CABLE	KABELBEFESTIGUNG
5	25869057/0	1	TUBO COLLEGAMENTO (1000 mm)	CONNECTING TUBE (1000 mm)	TUBE DE CONNEXION (1000 mm)	VERBINDUNGSRÖHR (1000 mm)
11	112735108/1	3	VITE	SCREW	VIS	SCHRAUBE
12	27598060/0	1	PROLUNGA SCARICO OLIO	OIL DISCHARGE EXTENSION	EXTENSION DECH. HUILE	ÖL ABFLUSS
13	18401001/1	1	GUARNIZIONE	OIL SEAL	GARNITURE	DICHTUNG
14	18737849/0	1	TAPPO PROLUNGA	OIL CAP	BOUCHON HUILE	OELVERSCHLUSS
15	325108044/0	1	CONVOGLIATORE	CONVEYOR	CONVOYEUR	KONVEYOR
21	12792611/0	2	VITE	SCREW	VIS	SCHRAUBE
22	12540260/0	2	ROSETTA	WASHER	RONDELLE	SCHEIBE
23	382598047/0	1	PROTEZIONE SILENZIATORE	MUFFLER PROTECTION	PROTECTION SILENCIEUX	AUSPUFFSCHUTZ
24	82750004/0	1	SILENZIATORE	MUFFLER	SILENCEUX	AUSPUFF
25	12360425/0	2	DADO	NUT	ECROU	MUTTER
26	12792611/0	2	VITE	SCREW	VIS	SCHRAUBE
27	12540260/0	2	ROSETTA	WASHER	RONDELLE	SCHEIBE
28	18738224/0	1	TUBO RACCORDO SCARICO	EXHAUST CONNECTING TUBE	TUBE DE CONNEXION ECHAPPEMENT	VERBINDUNGSRÖHR FÜR ABGASUNG
29	12737450/0	2	VITE	SCREW	VIS	SCHRAUBE
30	12540260/0	2	ROSETTA	WASHER	RONDELLE	SCHEIBE
31	12691115/0	1	VITE	SCREW	VIS	SCHRAUBE
32	12154210/0	1	DADO	NUT	ECROU	MUTTER
35	325394531/0	1	MANOPOLINA	KNOB	POIGNEE	GRIFF
36	182000216/0	1	ACCELERATORE	ACCELERATOR	ACCELERATEUR	GAS ZUG
37	112726389/0	1	VITE	SCREW	VIS	SCHRAUBE
38	12290800/0	1	DADO	NUT	ECROU	MUTTER
39	112726389/0	2	VITE	SCREW	VIS	SCHRAUBE
40	12540020/0	2	ROSETTA	WASHER	RONDELLE	SCHEIBE
41	12521310/0	2	ROSETTA	WASHER	RONDELLE	SCHEIBE



# SD98

www.ersatzteile-sevice.de



**PARTI ELETTRICHE**  
**ELECTRICAL PARTS**  
**PARTIES ELECTRIQUES**  
**ELETRISCHE TEILE**

2009

**5110.0**

1 / 1



# WÖLFNITZER WERKZEUGKISTE

N.	CODE	Q.TY	DESCRIZIONE	DESCRIPTION	DESCRIPTION	BESCHREIBUNG
1	182040150/0	1	CABLAGGIO	CABLES ASS.Y	ENS. CABLAGES	KABELSATZ
2	125722433/0	1	SCHEDA ELETTRONICA (GGP ENGINES)	ELECTRONIC CARD (GGP ENGINES)	ELECTRONIC CARD (GGP ENGINES)	CARTE ELECTRO-NIQUE (GGP ENGINES)
2	125722435/0	1	SCHEDA ELETTRONICA (B&S)	ELECTRONIC CARD (B&S)	CARTE ELECTRONIQUE (B&S)	ELEKTRONISCHE KARTE (B&S)
3	12735101/0	1	VITE	SCREW	VIS	SCHRAUBE
4	118450075/0	1	INTERRUTTORE AVVIAM.	STARTING SWITCH	INTERRUPTEUR DEMARR.	SCHALTER
6	118210023/0	1	CHIAVE AVVIAMENTO	STARTING KEY	CLEF A DEMARRAGE	SCHLÜSSEL FÜR START
7	18120002/1	1	BATTERIA	BATTERY	BATTERIE	BATTERIE
8	125430265/0	1	MOLLA	SPRING	RESSORT	FEDER
9	18736111/0	1	RELÉ AVVIAMENTO	STARTER RELAY	RELAIS D'ALLUMAGE	ANLASSRELAIS
10	12360352/0	2	DADO	NUT	ECROU	MUTTER
11	25065002/0	1	CAVO RELÉ AVV.	CABLE	CABLE	KABEL
12	18564864/1	1	CAPPUCCIO	PROTECTION	CAPUCHON	STECKER
13	12790781/0	1	VITE	SCREW	VIS	SCHRAUBE
15	33500007/0	2	PORTAFUSIBILE	FUSE CARRIER	TABLEAU DE FUSIBLE	SICHERUNGHALTER
15	33215000/0	2	COPERCHIO	COVER	COUVERCLE	DECKEL
16	33340040/0	1	FUSIBILE 10 A	FUSE 10 A	FUSIBLE 10 A	SICHERUNG 10 A
16	33340036/0	1	FUSIBILE 25 A	FUSE 25 A	FUSIBLE 25 A	SICHERUNG 25 A
17	12154510/0	2	DADO	NUT	ECROU	MUTTER
18	118450074/0	1	INTERRUTTORE FRIZIONE	CLUTCH SWITCH	INTERRUPTEUR EMBRAJAGE	KUPPLUNG SCHALTER
19	119410613/0	2	MICRO INTERRUTTORE	MICRO	MICRO	MIKRO
20	82040073/0	1	CABLAGGIO LAMPADA	CABLE	CABLES	KABEL
21	18459100/0	2	LAMPADA	FARILAMP FOR LIGHTS	LAMPE POUR PHARES	LAMPENFASSUN
22	19410608/1	1	MICRO FOLLE (MECC.)	NEUTRAL SWITCH (MECH.)	MICRO. POINT MORT (MEC.)	LEERLAUF MIKROSCH.(MECH.)
25	82180050/0	1	CARICA BATTERIE	BATTERY CHARGER	CHARGEUR DE BATTERIES	BATTERIELADEGERÄT
25	82180052/0	1	CARICA BATTERIE (U.K.)	BATTERY CHARGER (U.K.)	CHARGEUR DE BATTERIES (U.K.)	BATTERIELADEGERÄT (U.K.)



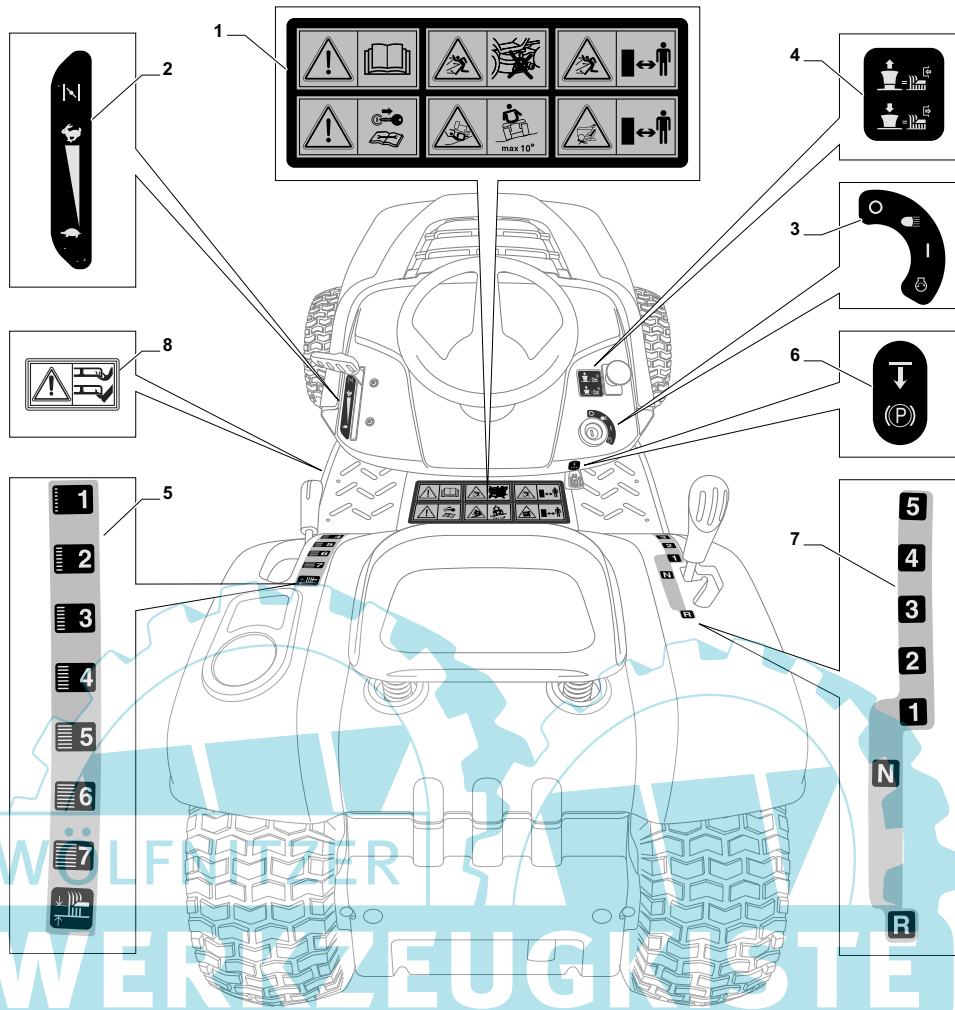
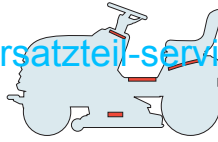

N.	CODE	Q.TY	DESCRIZIONE	DESCRIPTION	DESCRIPTION	BESCHREIBUNG
1	114362365/1	1	ETICHETTA	LABEL	ETIQUETTE	KLEBZETTEL
2	114363697/0	1	ETICHETTA	LABEL	ETIQUETTE	KLEBZETTEL
3	114363699/0	1	ETICHETTA	LABEL	ETIQUETTE	KLEBZETTEL
4	14361438/0	1	ETICHETTA	LABEL	ETIQUETTE	KLEBZETTEL
5	114363701/0	1	ETICHETTA	LABEL	ETIQUETTE	KLEBZETTEL
6	114363700/0	1	ETICHETTA	LABEL	ETIQUETTE	KLEBZETTEL
7	114363451/0	1	ETICHETTA	LABEL	ETIQUETTE	KLEBZETTEL
8	114356699/1	1	ETICHETTA	LABEL	ETIQUETTE	KLEBZETTEL



# SD98

www.ersatzteil-service.de

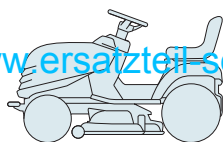

ELENCO NUMERICO

NUMERICAL LIST

LISTE NUMERIQUE

NUMERISCHE AUFSTELLUNG

2009

5199.0

1 / 1

CODE	TABLE	N.	Q.TY	CODE	TABLE	N.	Q.TY	CODE	TABLE	N.	Q.TY
112437506/0	5102.0	35	1	125033083/0	5104.0	42	1	125943009/0	5106.0	9	2
112620300/0	5103.0	8	1	125040635/0	5107.0	31	1	125943009/0	5106.0	11	2
112726389/0	5109.0	37	1	125040636/0	5106.0	13	1	125943010/0	5102.0	12	4
112726389/0	5109.0	39	2	125160047/0	5103.0	4	1	125943010/0	5102.0	18	2
112726389/0	5109a.0	37	1	125160048/0	5101.0	27	2	125943010/0	5102.0	26	1
112726389/0	5109a.0	39	2	125160049/0	5107.0	33	1	125943010/0	5102.0	36	2
112728692/0	5102.0	7	4	125160051/0	5104.0	23	1	125943010/0	5102.0	40	2
112735108/1	5109.0	11	4	125160052/0	5107.0	26	1	125943010/0	5108.0	2	1
112735108/1	5109a.0	11	3	125160055/0	5105.0	42	2	125943010/0	5109a.0	2	4
112735406/0	5102.0	15	3	12521310/0	5109.0	41	2	12604899/0	5104.0	38	1
112735406/0	5102.0	33	4	12521310/0	5109a.0	41	2	12604899/0	5106.0	30	1
112735406/0	5102.0	37	2	12521340/0	5105.0	14	1	12608950/0	5105.0	27	1
114356699/1	5111.0	8	1	12521350/0	5101.0	32	2	12609260/0	5107.0	8	2
114362365/1	5111.0	1	1	12521350/0	5104.0	6	1	12610800/0	5107.0	23	1
114363451/0	5111.0	7	1	12521350/0	5104.0	37	1	12622650/0	5103.0	9	1
114363697/0	5111.0	2	1	12521350/0	5105.0	22	4	12674700/0	5106.0	4	1
114363699/0	5111.0	3	1	12521350/0	5106.0	28	1	12691115/0	5109a.0	31	1
114363700/0	5111.0	6	1	12521360/0	5103.0	36	2	12691400/0	5101.0	33	2
114363701/0	5111.0	5	1	12521370/0	5103.0	14	1	12691400/0	5104.0	22	1
118203854/0	5101.0	39	2	12523040/0	5102.0	16	3	12691400/0	5107.0	21	1
118210023/0	5110.0	6	1	12523040/0	5102.0	38	2	12691600/0	5104.0	30	1
118399063/0	5107.0	36	1	12523060/0	5102.0	47	4	12691600/0	5105.0	21	4
118450074/0	5110.0	18	1	12523060/0	5104.0	24	1	12692050/0	5103.0	1	1
118450075/0	5110.0	4	1	12523060/0	5104.0	27	1	12692050/0	5105.0	4	1
118738231/1	5109.0	28	1	12523060/0	5104.0	47	1	12692050/0	5107.0	41	2
119410613/0	5110.0	19	2	12523060/0	5105.0	10	1	12692390/0	5103.0	35	1
12001010/0	5103.0	48	1	12523060/0	5106.0	16	1	12692695/0	5103.0	51	1
12001010/0	5103.0	67	2	12523060/0	5106.0	39	3	12735101/0	5110.0	3	1
12001010/0	5105.0	44	2	12523060/0	5107.0	42	2	12735403/0	5102.0	5	4
12139100/0	5107.0	66	2	12523070/0	5103.0	3	1	12735520/0	5105.0	17	1
12139430/0	5105.0	26	1	12523080/0	5107.0	34	1	12735599/0	5101.0	4	2
12139480/0	5107.0	16	2	12523080/0	5107.0	62	2	12735599/0	5101.0	22	2
12141418/0	5105.0	16	1	12523100/0	5103.0	52	2	12735599/0	5102.0	14	2
12141418/0	5108.0	4	1	12524010/0	5104.0	13	2	12735599/0	5104.0	3	4
12154210/0	5107.0	18	6	12524010/0	5107.0	22	1	12735599/0	5105.0	29	2
12154210/0	5109a.0	32	1	125270329/0	5105.0	28	1	12735599/0	5106.0	22	4
12154510/0	5106.0	6	1	125270330/0	5105.0	30	1	12735599/0	5106.0	32	2
12154510/0	5110.0	17	2	12540020/0	5109.0	40	2	12735694/0	5107.0	61	2
12155000/0	5103.0	43	2	12540020/0	5109a.0	40	2	12737320/0	5107.0	38	1
12155000/0	5104.0	9	1	12540040/0	5105.0	18	1	12737450/0	5109.0	29	2
12155000/0	5104.0	25	1	12540260/0	5102.0	46	4	12737450/0	5109a.0	29	2
12155000/0	5104.0	26	1	12540260/0	5103.0	2	1	127590066/0	5103.0	64	2
12155000/0	5104.0	33	1	12540260/0	5107.0	14	2	12790781/0	5110.0	13	1
12155000/0	5104.0	45	1	12540260/0	5109.0	22	2	12792611/0	5102.0	45	4
12155000/0	5105.0	6	1	12540260/0	5109.0	27	2	12792611/0	5109.0	21	2
12155000/0	5105.0	24	4	12540260/0	5109.0	30	2	12792611/0	5109.0	26	2
12155000/0	5106.0	24	1	12540260/0	5109a.0	22	2	12792611/0	5109a.0	21	2
12155010/0	5101.0	38	2	12540260/0	5109a.0	27	2	12792611/0	5109a.0	26	2
12155010/0	5103.0	28	2	12540260/0	5109a.0	30	2	12793102/0	5107.0	13	2
12155010/0	5105.0	11	1	12543000/0	5107.0	37	1	12793701/0	5106.0	12	1
12155020/0	5107.0	29	1	125430261/0	5106.0	5	1	12818690/0	5107.0	17	6
12156602/0	5103.0	32	2	125430262/0	5104.0	34	1	135061504/0	5107.0	11	1
12156602/0	5103.0	37	1	125430263/0	5101.0	28	2	135062013/0	5104.0	20	1
12156602/0	5106.0	36	3	125430264/0	5101.0	31	2	14361438/0	5111.0	4	1
12156602/0	5106.0	43	3	125430265/0	5110.0	8	1	18120002/1	5110.0	7	1
12156602/0	5107.0	35	1	125493009/0	5105.0	31	4	182000215/0	5109.0	36	1
12156602/0	5107.0	53	4	125510103/0	5103.0	38	2	182000216/0	5109a.0	36	1
12290800/0	5109.0	38	1	125510104/0	5103.0	21	1	182000598/0	5103.0	62	2
12290800/0	5109a.0	38	1	125510107/1	5106.0	35	3	182040150/0	5110.0	1	1
12293201/0	5101.0	3	2	125510109/0	5103.0	23	1	18375051/1	5109.0	4	4
12293201/0	5101.0	25	2	125520007/0	5103.0	7	1	18375051/1	5109a.0	4	4
12293201/0	5103.0	29	2	125570003/0	5103.0	10	1	18400912/0	5105.0	23	1
12293201/0	5104.0	36	1	125590014/0	5103.0	64	2	18401001/1	5109.0	13	1
12293201/0	5105.0	9	1	125590015/0	5105.0	48	2	18401001/1	5109a.0	13	1
12293201/0	5105.0	13	1	125601579/0	5106.0	14	1	18459100/0	5110.0	21	2
12293201/0	5106.0	17	1	125601586/0	5107.0	25	1	18564864/1	5110.0	12	1
12293201/0	5107.0	28	1	125670022/0	5107.0	30	1	18736111/0	5110.0	9	1
12293201/0	5107.0	45	2	125670023/0	5103.0	22	1	18737849/0	5109.0	14	1
12295200/0	5106.0	37	3	125722433/0	5110.0	2	1	18737849/0	5109a.0	14	1
12295300/0	5103.0	55	1	125722435/0	5110.0	2	1	18738224/0	5109a.0	28	1
12360352/0	5110.0	10	2	125722472/0	5102.0	51	1	19035000/0	5107.0	3	2
12360425/0	5104.0	15	2	12587100/0	5103.0	54	1	19216040/0	5107.0	6	4
12360425/0	5109.0	25	2	125943006/0	5108.0	12	4	19216041/0	5107.0	24	1
12360425/0	5109a.0	25	2	125943006/0	5109.0	2	4	19410608/1	5110.0	22	1
12369500/0	5103.0	26	1	125943009/0	5101.0	12	4	22160400/0	5103.0	27	1
12379511/0	5103.0	46	2	125943009/0	5101.0	15	6	22160400/0	5107.0	63	2
12436030/0	5103.0	15	1	125943009/0	5101.0	17	2	22430216/0	5107.0	39	1
12436050/0	5104.0	7	1	125943009/0	5101.0	18	2	22524970/2	5101.0	36	2
12502804/0	5107.0	5	2	125943009/0	5101.0	40	4	22524970/2	5104.0	44	1

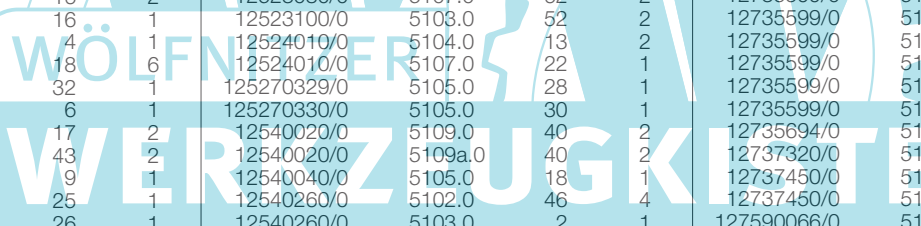



CODE	TABLE	N.	Q.TY	CODE	TABLE	N.	Q.TY	CODE	TABLE	N.	Q.TY
22672151/0	5103.0	20	1	325547208/0	5102.0	39	1				
22672151/0	5105.0	8	1	325547225/0	5101.0	5	1				
22680009/0	5105.0	19	1	325547227/0	5101.0	6	1				
24487998/0	5101.0	1	1	325547231/0	5104.0	4	2				
24487998/0	5106.0	41	3	325547231/0	5106.0	23	2				
25034002/1	5103.0	47	4	325547231/0	5106.0	31	1				
25038002/1	5104.0	31	2	325547233/0	5103.0	25	1				
25065002/0	5110.0	11	1	325580503/0	5102.0	23A	1				
25122200/2	5103.0	61	4	325580504/0	5102.0	23B	1				
25160016/0	5103.0	53	1	325600077/0	5108.0	1	1				
25160021/0	5104.0	11	1	325600078/0	5108.0	11	1				
25160027/0	5104.0	32	1	325600079/0	5108.0	13	1				
25160501/0	5107.0	7	2	325600080/0	5102.0	20	1				
25430213/0	5104.0	46	1	325735126/0	5109.0	3	1				
25430226/0	5105.0	5	1	325735126/0	5109a.0	3	1				
25430242/0	5108.0	3	1	325735515/0	5106.0	10	1				
25463200/0	5107.0	65	2	325735519/0	5103.0	24	1				
25510035/0	5105.0	7	1	325785297/0	5106.0	8	1				
25510072/0	5107.0	43	2	325785298/0	5102.0	11	1				
25510079/0	5101.0	2	2	325785315/0	5105.0	32	2				
25580018/0	5104.0	14	2	325785317/0	5102.0	4	1				
25601554/0	5104.0	28	1	325785318/0	5103.0	5	1				
25601555/0	5104.0	21	1	325785331/0	5101.0	13	1				
25601567/0	5104.0	12	1	325785333/0	5101.0	14	1				
25601571/0	5107.0	12	2	325820105/0	5101.0	30	1				
25670005/1	5103.0	66	2	325820109/0	5101.0	26	1				
25670005/1	5105.0	41	2	325840029/0	5103.0	39	1				
25670005/1	5105.0	43	6	325961219/0	5102.0	22	1				
25670007/0	5107.0	15	2	33215000/0	5110.0	15	2				
25670008/1	5106.0	34	3	33340036/0	5110.0	16	1				
25670008/1	5106.0	44	6	33340040/0	5110.0	16	1				
25670008/1	5107.0	52	8	33500007/0	5110.0	15	2				
25670011/0	5104.0	8	1	382000565/0	5107.0	51	2				
25670011/0	5106.0	26	2	382000566/0	5103.0	31	1				
25722463/0	5102.0	41	1	382000567/0	5105.0	12	1				
25743000/0	5103.0	13	1	382000568/0	5104.0	5	1				
25785213/0	5103.0	12	1	382000569/0	5106.0	27	1				
25795001/1	5109.0	1	1	382000597/0	5105.0	46	2				
25795001/1	5109a.0	1	1	382004620/0	5106.0	15	1				
25840012/0	5106.0	38	3	382034030/0	5103.0	45	1				
25869057/0	5109.0	5	1	382076954/0	5102.0	1	1				
25869057/0	5109a.0	5	1	382076955/0	5102.0	1	1				
25950000/0	5103.0	63	2	382207204/0	5107.0	4	2				
25950000/0	5105.0	47	2	382230369/0	5103.0	41	1				
27598060/0	5109.0	12	1	382230371/0	5103.0	42	1				
27598060/0	5109a.0	12	1	382230373/0	5103.0	41	1				
27943051/0	5103.0	11	2	382230375/0	5103.0	42	1				
322110233/0	5103.0	68	2	382318229/0	5106.0	2	1				
322110233/0	5105.0	45	2	382318231/0	5106.0	3	1				
325033086/0	5107.0	2	2	382318233/0	5105.0	2	1				
325038006/0	5106.0	7	2	382318235/0	5104.0	29	1				
325038007/0	5103.0	40	2	382318237/0	5106.0	29	1				
325038008/0	5103.0	6	1	382318239/0	5106.0	21	1				
325060038/0	5101.0	29	1	382500033/0	5104.0	2	1				
325108044/0	5109.0	15	1	382547061/0	5101.0	35	1				
325108044/0	5109a.0	15	1	382564209/0	5107.0	1	1				
325110382/0	5102.0	34	1	382598045/0	5109.0	23	1				
325110383/0	5102.0	25	1	382598047/0	5109a.0	23	1				
325110384/0	5102.0	42	1	382774259/0	5105.0	3	1				
325110385/0	5102.0	43	1	382785169/0	5101.0	11	1				
325110391/0	5104.0	1	1	382785179/0	5101.0	16	1				
325110396/0	5102.0	25	1	382820016/0	5104.0	35	1				
325110398/0	5102.0	25	1	382820151/0	5101.0	37	1				
325110399/0	5102.0	34	1	82004346/0	5107.0	64	2				
325110401/0	5102.0	34	1	82004618/0	5107.0	32	1				
325120202/0	5102.0	17	1	82040073/0	5110.0	20	1				
325120203/0	5102.0	21	1	82180050/0	5110.0	25	1				
325122002/0	5101.0	34	2	82180052/0	5110.0	25	1				
325253011/0	5104.0	43	1	82601509/0	5105.0	25	1				
325260003/0	5102.0	19	2	82700001/0	5107.0	44	2				
325263302/0	5102.0	6	1	82750004/0	5109.0	24	1				
325270325/0	5102.0	13	2	82750004/0	5109a.0	24	1				
325318232/0	5107.0	27	1								
325318235/0	5105.0	15	1								
325318243/0	5103.0	34	1								
325394531/0	5109.0	35	1								
325394531/0	5109a.0	35	1								
325394532/0	5105.0	1	1								
325394533/0	5106.0	1	1								
325394534/0	5104.0	41	1								
325410887/0	5102.0	2	1								
325410888/0	5102.0	3	1								
325500041/0	5101.0	20	1								
325500043/0	5101.0	21	1								

